



SOCCER
SPECIFIC.COM

Physical Preparation for Soccer
Mladen Jovanović Training System

Belgrade, July 2007.

“Don’t lose sight of the forest for the trees!” --- Folk wisdom

“As complexity rises, precise statements lose meaning and meaningful statements lose precision!”--- Lofti Zadeh, “father” of the Fuzzy logic

Acknowledgements

- I want to thank all the following people that have directly or indirectly influenced my 'development' and the development of my training system and philosophy. From these people I have 'stolen' the most.

Charlie Francis, Michael Boyle, Dave Tate, Jim Wendler, Tim Noakes, Stuart McGill, Shirley Sahrman, Martin Rooney, James Smith, Jim Cavallini, Fergus Connolly, Joe Kenn, Charles Poliquin, Mel Siff, Pavel Tsatsouline, Al Vermiel, Scott Vass, David Bishop, Alwyn Cosgrove, Christian Thibaudeau, Eric Cressey, John Berardi, Marshal Burt, Guisepe Guelli, Kelly Bagget, Lon Kilgore, Mark Rippetoe, Richard Schmidt, Richard Gibbens, Carl Valle, Lee Taft, Ian Jeffreys, Alexander Michalow, Scott Plisk, Vern Gambetta, Lyle McDonald, Vladimir Koprivica, Ognjen Milić, Jovan Buha, Predrag Rogan, Aleksandar Janjić, Milan Milanović....

- Special thanks to Mick McDermott from F.C. Al Ain for allowing me to use Session Planner at www.soccerspecific.com

Acknowledgements

- I also want to thank to the coaches from **FC RAD**. They were very 'open' for my ideas, provided me the great learning experience, creative critiques and new ideas. Without them, and without our excellent soccer players there wouldn't be this presentation at all!
- Also, thanks to all members of www.charliefrancis.com, www.michaelboyle.biz and www.the-elite-edge.com forums for listening my 'rant' and giving me suggestions and creative critiques.
- Thank you guys!

A little rant...

- First off, I wrote this presentation, or whatever you want to call it, for me and my selfish needs!
- I wanted to classify, organize and put all mine ideas on paper, so I could have easier review and more easily indentify weak ponts in my knowledge and thus direct my learning and development into those areas
- I also tried to write it to be 'reader friendly'. But due great material covered, that was not possible. Please, if you find anything that you don't understand, please contact me.
- This system grows and evolves together with me. At the moment you read this I allready changed something....
- I hope I will have time and will to update my new understandings into new versions of this presentation
- **Good luck with 'digesting it'!**

Mladen Jovanović

Table of Contents

<u>Soccer Game Demands</u>	7
<u>Athlete Evaluation</u>	52
<u>Training System</u>	70
<u>Technical Work Component</u>	104
<u>Tactical Work Component</u>	108
<u>Speed Training Component</u>	111
<u>Plyometric Training Component</u>	127
<u>Strength Training Component</u>	135
<u>Work Capacity Component</u>	173
<u>Metabolic Conditioning Component</u>	184
<u>Recovery</u>	193
<u>Warm-Up</u>	197
<u>In-Season Training</u>	200
<u>About the author</u>	204

Soccer Game Demands

- When watching soccer match, usually on TV, viewers have the (**false**) perception that soccer is constant running activity, where the players are in constant high-intensity motion all the time
- Viewers think this because they are watching the ball, the area of the field and the players around it
- But if they pick one player and watch his movement patterns during the course of the game, the results will be shocking!
- **Most of the time, the players are walking, jogging or just standing, with only brief periods of high-intensity activity**
- For this reason, soccer game can be considered **HIIE activity!**
- HIIE stands for **High Intensity Intermittent Exercise**, which describes the type of activity where the athlete performs short-lasting high-intensity activity (mostly shorter than 30secs) interspersed with periods of passive or active rest during which athlete recovers to a certain degree

- Therefore success in a soccer match (viewed from physical aspect) is determined by the (a) **quality** of those short bursts (speed and power) and (b) the **ability to recover** in shortest time
- This would allow the soccer player to repeat high-intensity bursts more frequently or without drop-off in quality
- This will in turn, enable players to more efficiently (and more frequently) complete tactical tasks, such as marking, evade marking, run into space, tackling, etc, which will result in faster game and ground covered (all at higher intensities)
- Anyway, this should be put into 'context', which depends on the style of play, role played, game intelligence, etc.
- Experienced and older players, while having less power, speed and ability to recover, will usually be better on the field, due their appropriate positioning and reading the game (*'sense for the game' and experience*)
- Although these short bursts represent minimal percentages of game activities, they are usually crucial for the game outcome and for this very reason, **soccer should be considered as speed and power sport**, rather than endurance sport, although both aspects are important

- If we depict **hypothetical** activity of a soccer player we may get the following picture:

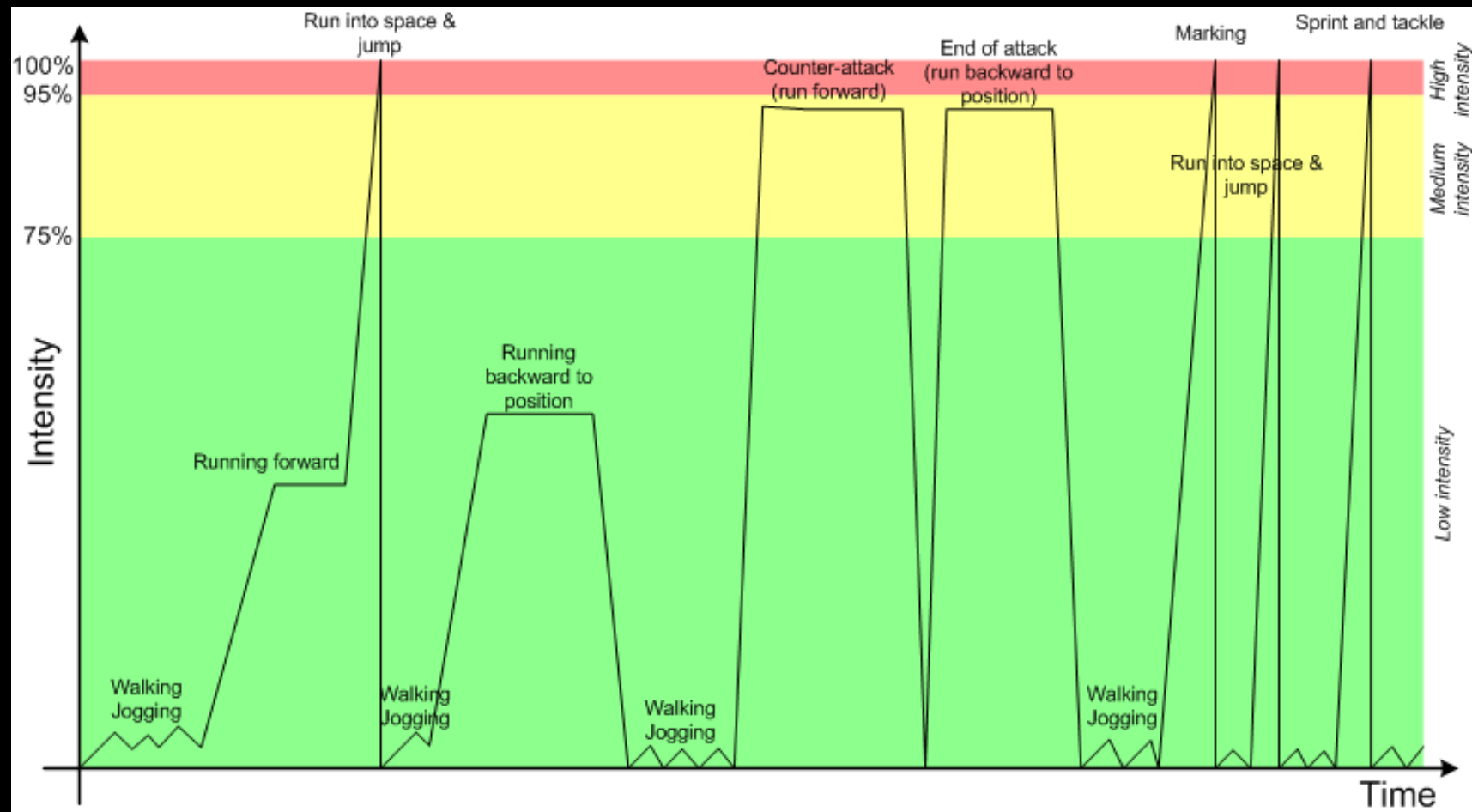

- Most of the time players perform movements (tactical & technical elements) which are **low intensity** in nature. However, they perform movements of **high and medium intensity**, which are 'usually' of short duration less frequently

- From the following picture, it can be concluded that 'fatigue' in soccer can result from:
 1. **Prolonged low-intensity activities** (jogging, running – tactical movements)
 2. **Repeated short duration high intensity activities** (like sprint into space, jumps, shoot, tackle, etc) with short break between (*this is called RSA; Repeat Sprint Ability*)
 3. **Prolonged medium and high intensity activities** (this doesn't usually happen that often, but it may happen and it is almost always shorter than 30sec - *this is called Speed Endurance*)

- Training system must address all those above mentioned 'situations' that can arise in the real game

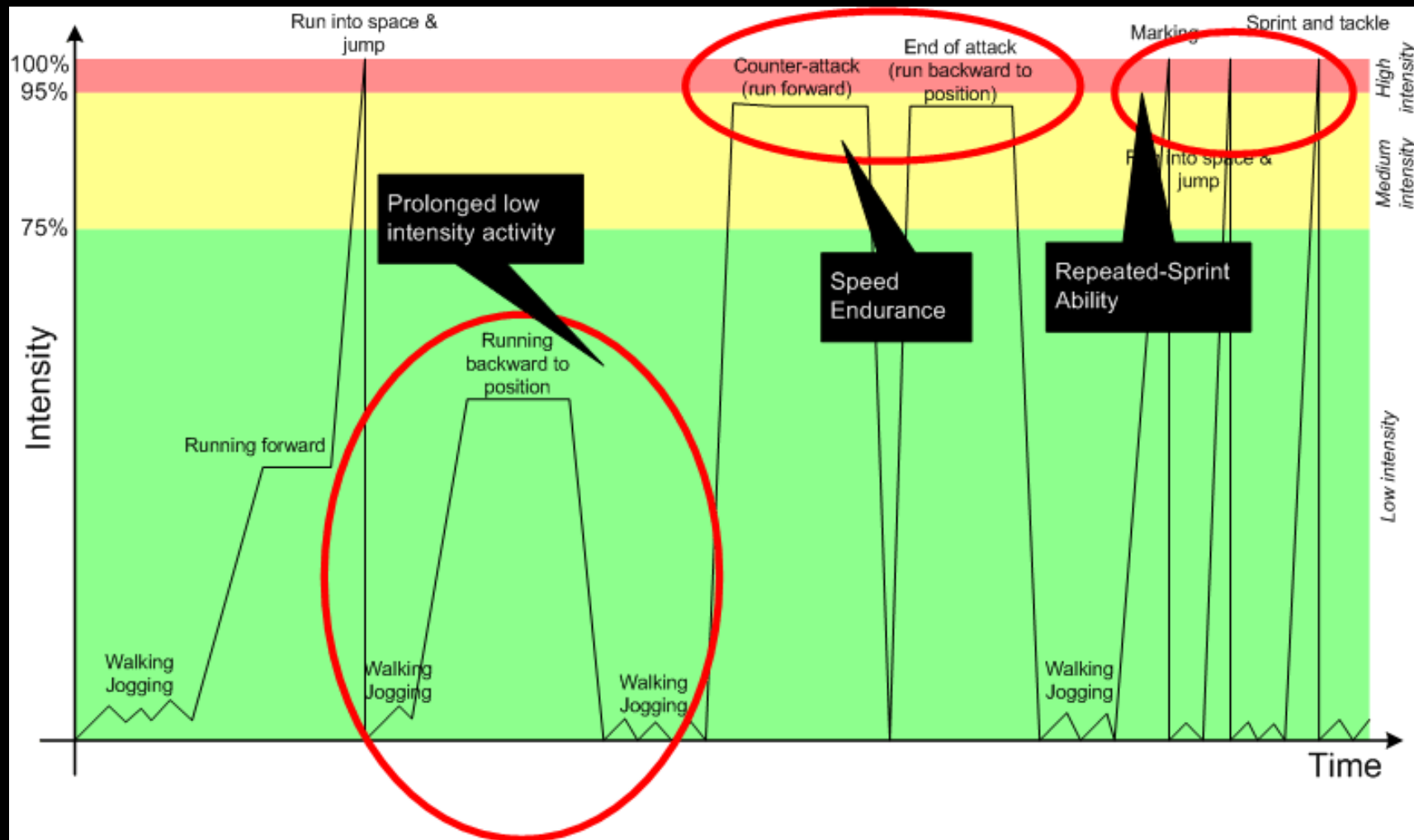

- Addressing the ‘situation’ of prolonged low intensity activities, and more importantly, **building the ‘foundation’** for other more metabolically demanding situations (see *Plateau Phenomena*) is one of the goals of the **Work Capacity Component** of my system
- One may say that, one of the goals of Work Capacity Component is to build aerobic power (VO₂max) and aerobic capacity (LT; Lactate Threshold; OBLA; Fat Power, etc)
- This may be true, but I don’t like these terms, because they are misleading and represent derivatives of the *cardiovascular/anaerobic model* of fatigue, which is old and inaccurate
- I am more inclined toward a more complex (system) model made popular by Tim Noakes; Central Governor Model (see mine [HPF](#))
- Thus, the goal of the Work Capacity Component is to improve player performance by increasing their ability to carry work and recover from it as fast as possible – this will usually result in increased VO₂max, but this is not the goal per se!
- One of the important aspects of the Work Capacity Component is the objective of building ‘aerobic power’, while not having negative effects on speed and power of the athletes and causing too much fatigue

- One of the methods/means used in Work Capacity Component is **Tempo Running**.
- Tempo running is my way of (*general*) 'aerobic development', which is intermittent in nature and thus more suited toward soccer players than long slow distance running
- Tempo running, uses runs from 100-300m @75% of maximal speed, which is fast enough to cause a homeostasis perturbation and not that fast to cause great metabolic or CNS fatigue, and thus impair speed and power development

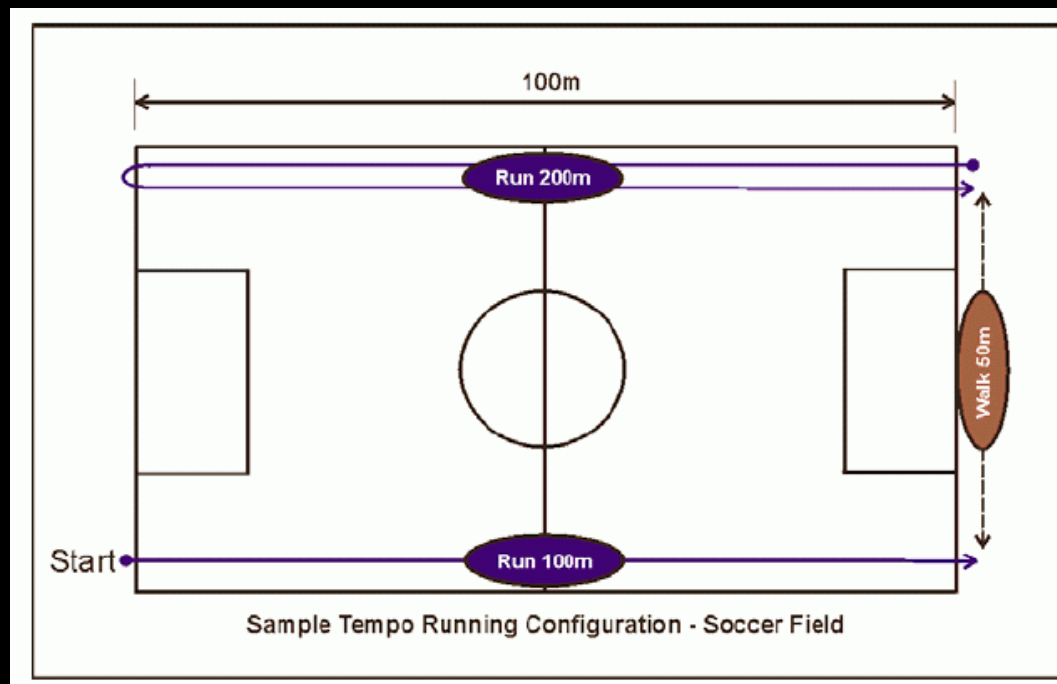

- Another aspect of tempo is that the total distances are from 1,000-4,000m which are low compared to LSD running. This results in avoidance of over-use injuries of the ankle and knee
- Since the **speed of recovery** is important for soccer players, tempo purposely perturbs homeostasis with the highest allowable low-intensity activity (75%) and then 'requires' players to recover during the pauses – this helps train the player's ability to recovery
- So this is actually a '**recovery**' training method
- It results in increased recovery ability; increased VO₂max, but not vice versa!
- Tempo is done on the field where the length is run and width is walked. It can also be done in 'shuttle' arrangement, where the width is run and the players stand during the recovery periods (add 1,25sec per turn)
- It is recommended ideally to do tempo barefoot – this will strengthen the arches and prevent ankle and knee injuries

- I like to do two types of tempo

1. **Type A** – where the total distance is increased and duration/organizations of the runs are changed as a way of progression
2. **Type B** – where the total distance is the same, while the recovery period is decreased as the recovery ability of the players increases

The speed of the run is the same (under 75%, or about 18sec for 100m, 38sec for 200m and 58sec for 300m)

Example of 'Type A' Tempo

Session #1	Session #2	Session #3	Session #4
<p>100+100+100+100 100+100+100+100 100+100+100+100</p>	<p>100+200+100+100 100+100+200+100 100+200+100+100</p>	<p>100+200+100+100 100+200+200+100 100+200+100+100</p>	<p>100+200+200+100 100+200+300 100+200+200+100</p>
<p>100s for 18sec + represent 50m walk (40-50sec)</p>	<p>100s for 18sec 200s for 38sec + represent 50m walk (40-50sec)</p>	<p>100s for 18sec 200s for 38sec + represent 50m walk (40-50sec)</p>	<p>100s for 18sec 200s for 38sec 300s for 58sec + represent 50m walk (40-50sec)</p>
<p>2mins between sets</p>	<p>2mins between sets</p>	<p>2mins between sets</p>	<p>2mins between sets</p>
<p>Total Distance: 1200m</p>	<p>Total Distance: 1500m</p>	<p>Total Distance: 1600m</p>	<p>Total Distance: 1800m</p>

Example of 'Type B' Tempo

Session #1	Session #2	Session #3	Session #4
2(sets)x8(reps)x100m	2(sets)x8(reps)x100m	2(sets)x8(reps)x100m	2(sets)x8(reps)x100m
100s for 18sec 50secs between reps	100s for 18sec 40secs between reps	100s for 18sec 35secs between reps	100s for 18sec 30secs between reps
3mins between sets	3mins between sets	3mins between sets	3mins between sets
Total Distance: 1600m	Total Distance: 1600m	Total Distance: 1600m	Total Distance: 1600m

- The goal of the **Metabolic Conditioning Component** of my system is to address the demands of repeated short duration high intensity activities with short breaks between (**RSA**) and prolonged medium and high intensity activities (**SE**)
- Some may call Metabolic Conditioning an ‘anaerobic endurance training’, but again this is bad title, because muscle cells are never out of oxygen - yet another flaw of cardiovascular/anaerobic model of fatigue
- Same as the Work Capacity Component, the goal of Metabolic Conditioning is to improve Repeat Sprint Ability and Speed Endurance (and recovery from it), although *Lactate Buffering*, *Lactate Clearance*, *Maximal Accumulated Oxygen Debt* will follow as a result of increased performance.

- The goal of **RSA training** is to improve the recovery processes between short sprints or high intensity activities, which will in turn allow the players to perform them more frequently or/and without a significant drop-off in quality

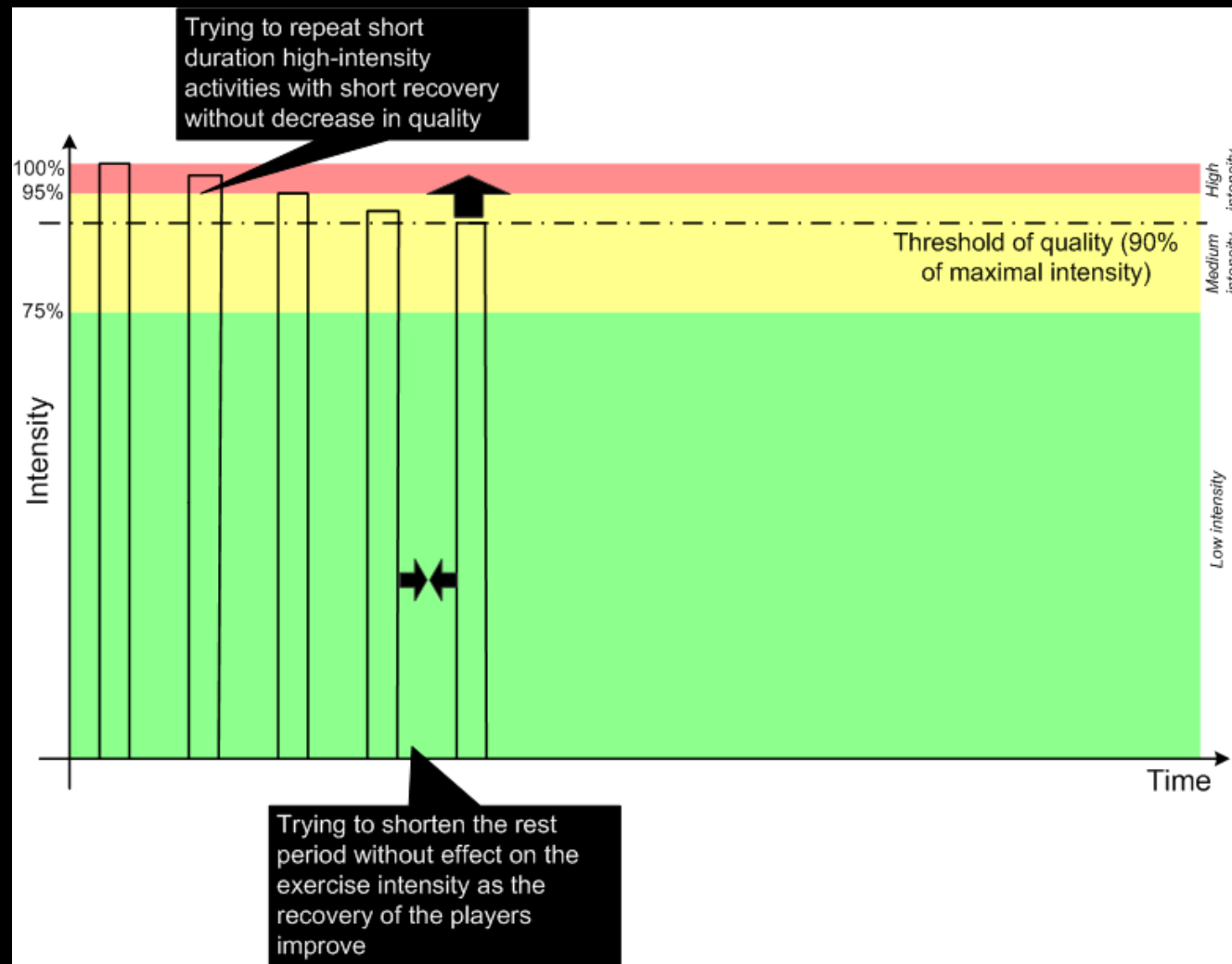

- RSA training can be progressed by increasing the number of reps (although after some point this will be inappropriate, because a large number of reps will never happen in a game) and/or by decreasing rest periods (which is better method), but without allowing the quality to fall under 90% of maximum
- **It is important to remember that the BEST method for improving RSA is to improve speed and power and not by doing repeated sprints!**
- Since both RSA and SE training 'fight' for the same 'adaptive resources' as speed and power training, they shouldn't be emphasised in the same training period and speed and power (along with work capacity; see Plateau Phenomena) should be already 'in place' before metabolic conditioning takes place
- Because speed and power training and Work Capacity don't fight for the same resources, they can be both done at the same training period depending on the context (competition calendar, evaluation of the players etc)

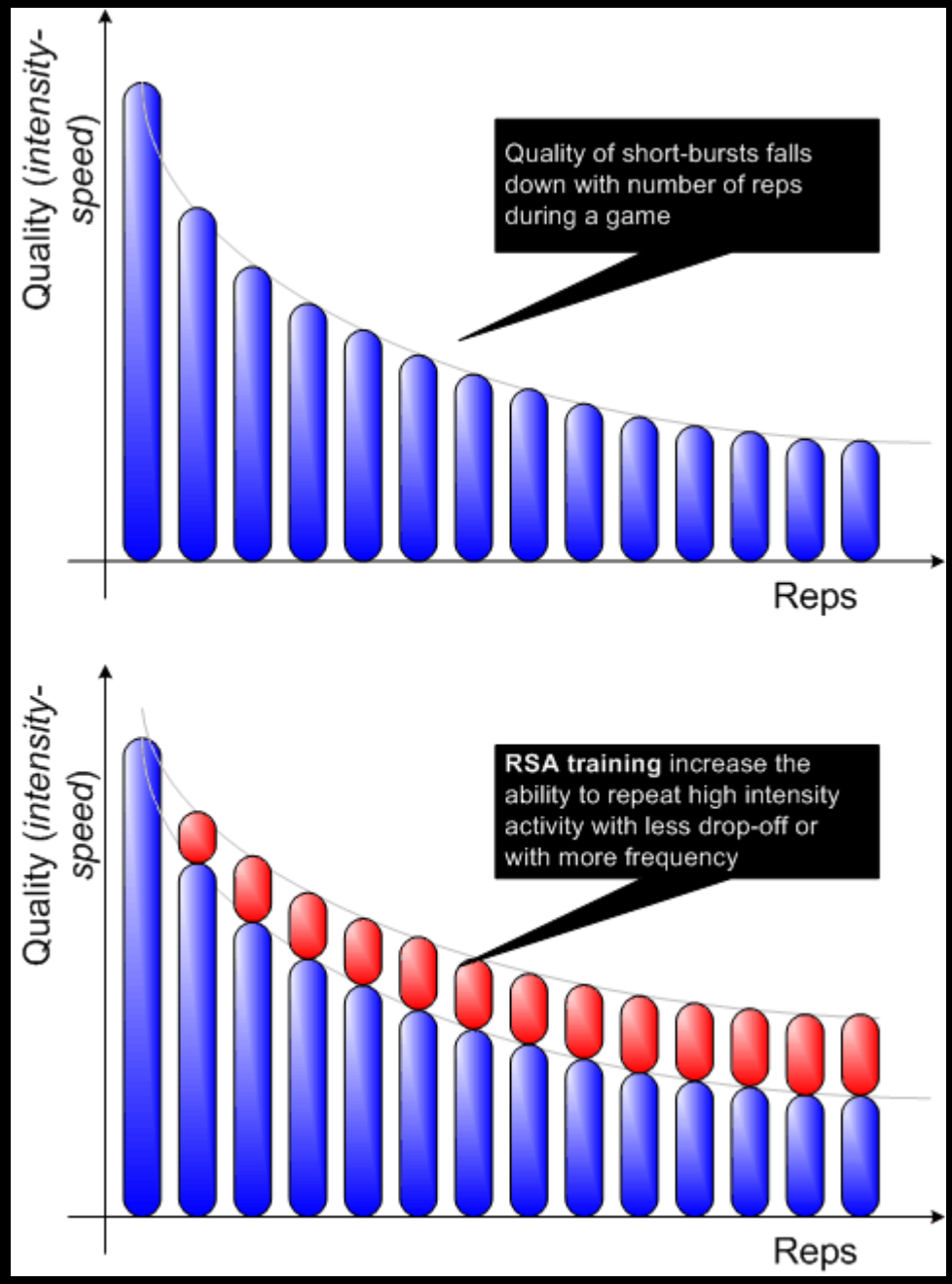

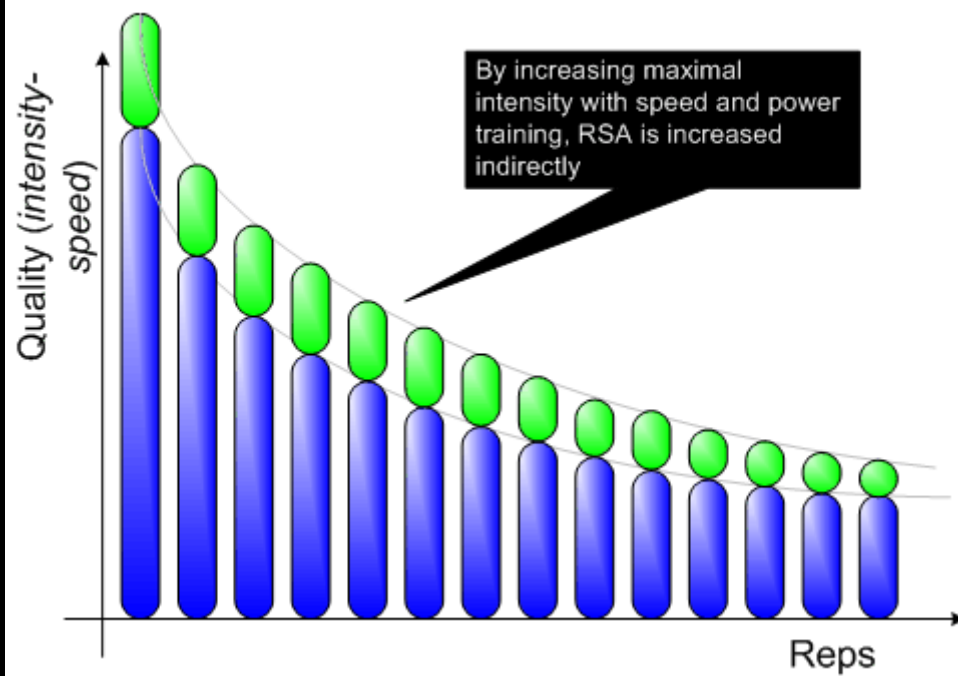
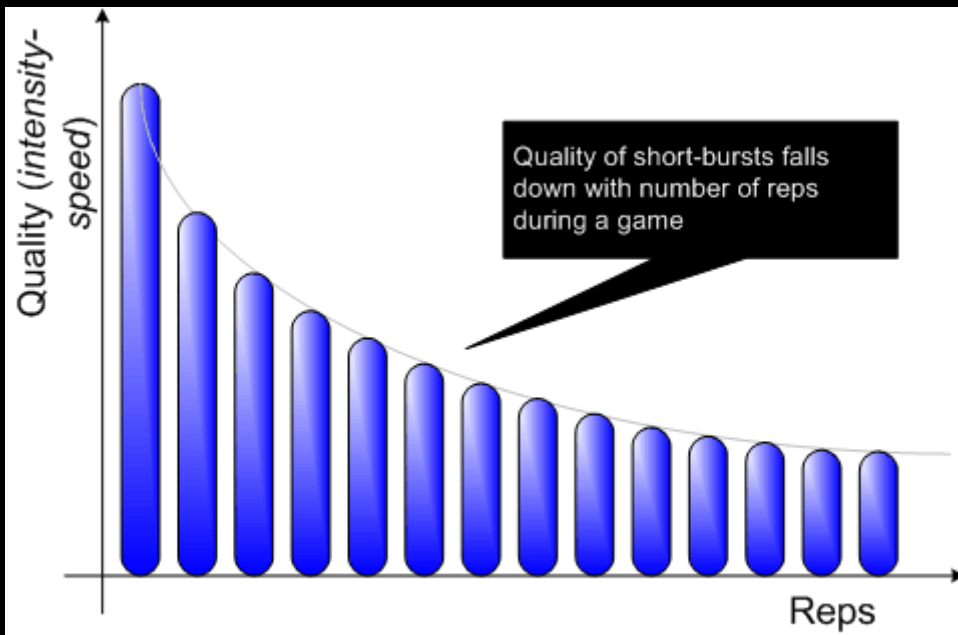

- Because RSA increases indirectly with speed and power training, along with work capacity training, Metabolic Conditioning should be completed sparingly and only as a 'dot to an i', after appropriate levels of speed, power and 'aerobic power' (see *Plateau Phenomena*) are developed
- In other words, Metabolic Conditioning is not necessary to carry out year long, although this, again, depends on the context
- The **Plateau phenomena** says that improvements in 'aerobic power' (expressed as VO₂max) will yield positive improvements of RSA up until a certain point. After that point, further increase in 'aerobic power' will not yield improvements in RSA and may lead to negative effects to speed and power (Scott Vass)
- This phenomena was showed in groups of athletes with similar high VO₂max, but different RSA values, which means that RSA depends on other factors besides 'aerobic power'
- Practically, up until some point 'aerobic power work' will transfer to RSA as well, but after that point more specific metabolic conditioning work have to take place to further increase RSA

- The goal of **Speed Endurance training** is to increase the ability to PROLONG high-intensity activity without a drop-off in quality
- The Speed Endurance training, depending on the duration of the rest period, can be further classified to:
 1. **Production Training** – where the aim is to improve ability to prolong high-intensity activity without the drop-off in quality with FULL recoveries between reps
 2. **Toleration Training** – where the aim is to improve ability to RECOVER after speed endurance work with uncomplete recovery between reps and also trying to minimize drop-off in quality
- Speed Endurance is very rarely seen in a game, especially ‘Toleration Type’, thus it should be done with very small volume over the year
- Speed Endurance is very ‘draining’ and cause a lot of fatigue, thus it should be planned smartly

- One of the objectives of SE training is to purposely induce fatigue in players to improve their performance under the state of fatigue (rehearsal under fatigue context) and 'mental toughness'
- Instead of playing for 75mins, players can perform SE training and then practice technique/tactics to 'simulate' last 15mins of the match, or the most crucial part of the match where most of the goals are given/get.
- Yet again, this should be done with great care

Production Speed Endurance Training

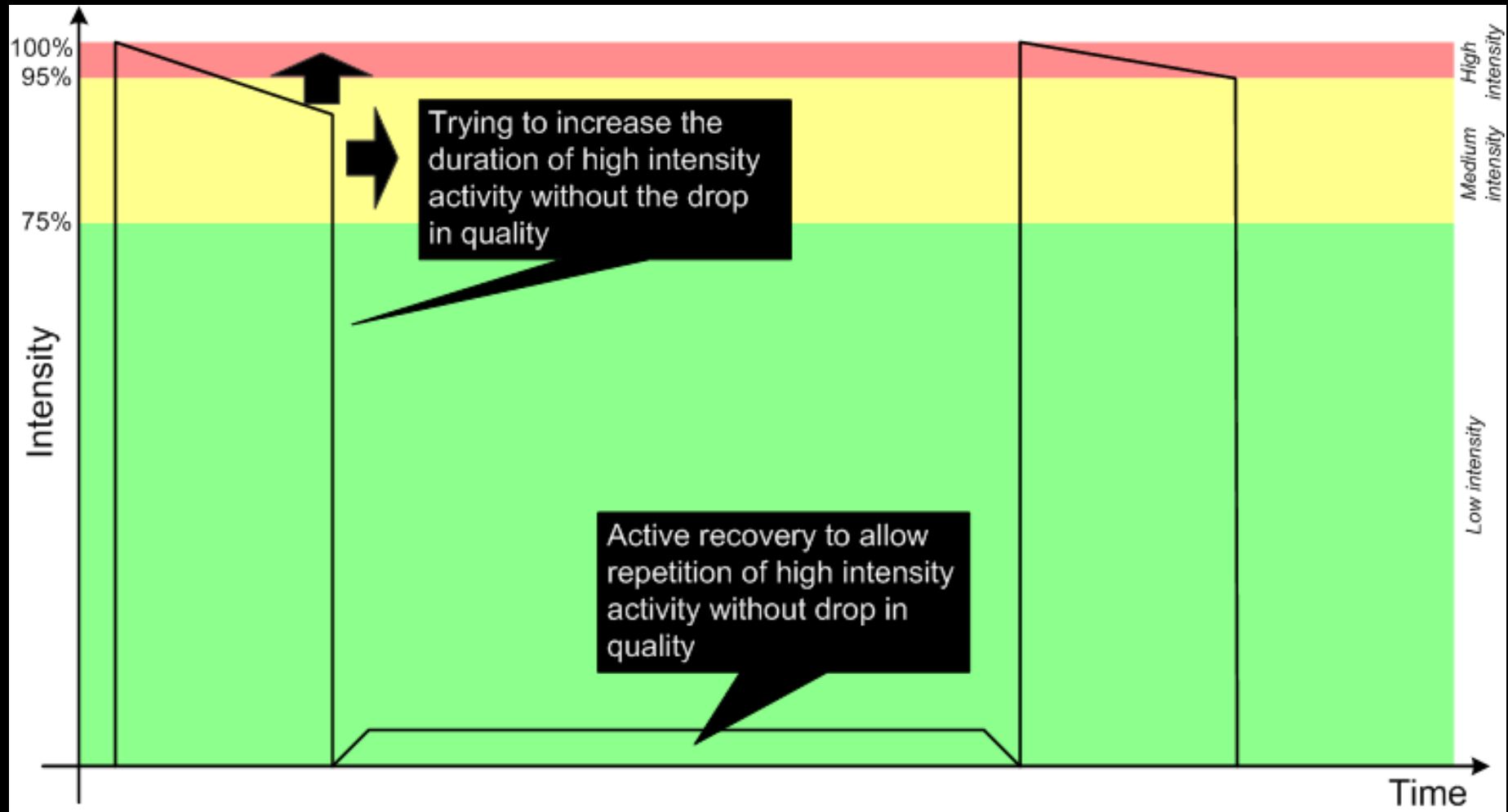

Toleration Speed Endurance Training

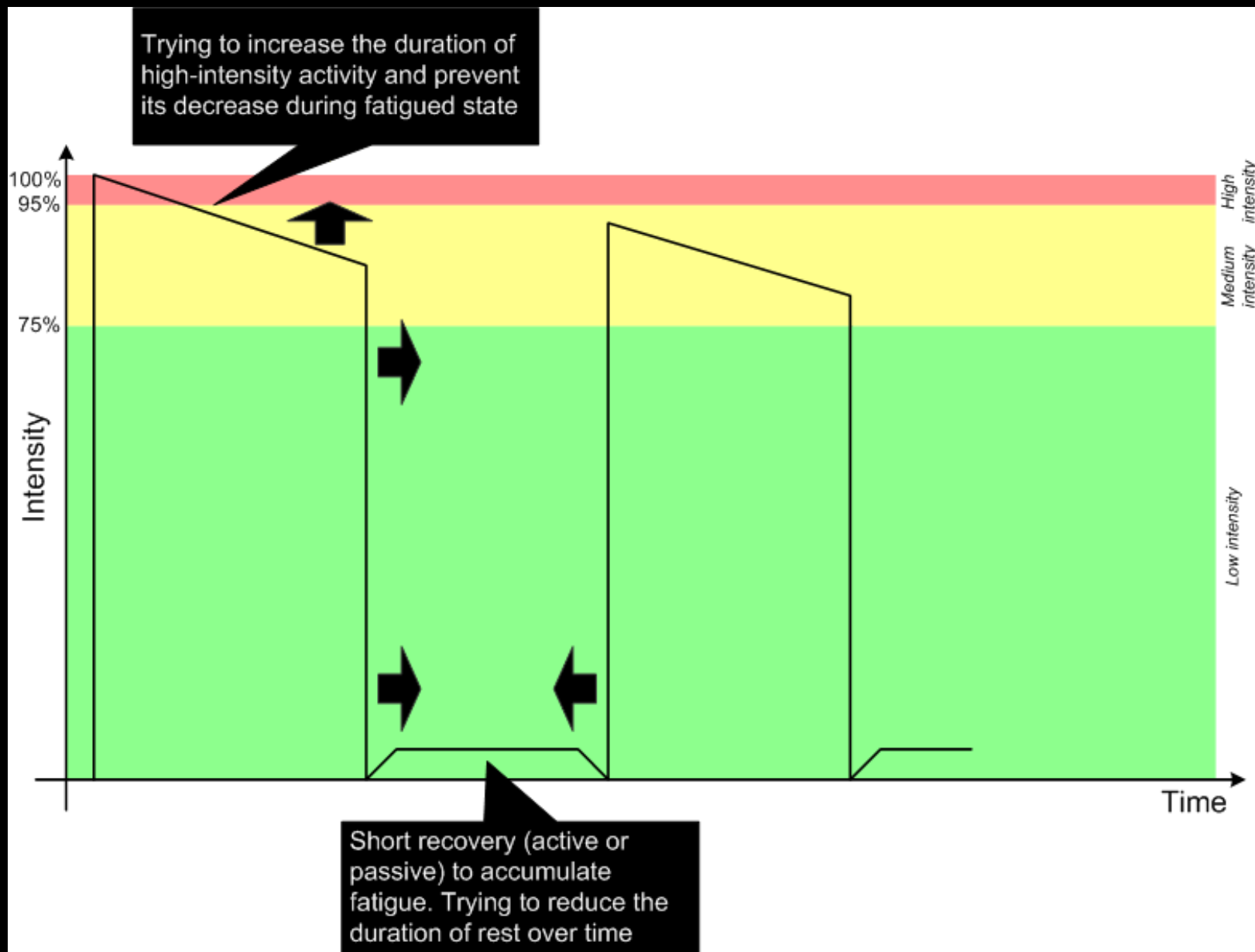

- The progression of SE training can be build around increasing number of reps, duration of the reps and decreasing the recovery time between
- **Small Sided Games** like 1v1, 2v2 and 3v3 (with the aim in metabolic conditioning) can be considered (*specific/competition*) SE training, but in reality they are more a blend between SE and RSA, becasue players have some short recoveries during them, and thus can be of greater duration than ordinary (*general*) SE training (shuttles, intensive tempo etc) which should be limited to 30secs at most



- To summarize...
- 'Energy System Development', in my system, is approached with two different components: (a) Work Capacity Component and (b) Metabolic Conditioning Component
- Work Capacity Component, among other goals, has the goal of addressing fatigue from prolonged low intensity activities during a match and building the 'foundation' (aerobic power and capacity; see Plateau Phenomena) for Metabolic Conditioning
- Metabolic Conditioning is geared toward improving the RSA and SE qualities of the players by utilizing various means (repeated sprints, 1v1-3v3, shuttles, etc)
- Since Metabolic Conditioning is 'gruelling' and fights for the same 'adaptive resources' as speed and power training (due its high intensity) it should be done sparingly, and only after appropriate levels of speed and power and work capacity are achieved.
- Metabolic Capacity is a 'dot to an i'

- In the study by Rampinini *et al.* (2006) they found significant relationship between peak speed during the incremental field test (similar to $v\dot{V}O_2\text{max}$ or **aerobic power**) and distance covered at high (HIR; >14.4km/h) and very high running speed (VHIR; >19.8km/h) along with total distance covered (TD) during a match
- They also found significant correlations between **RSA_{mean}** and distance covered at high running speed (VHIR; >19.8km/h) and sprinting (>25.2 km/h)
- They haven't found any significant relationship between **RSA_{decrement}** and any match-related performance, but it cannot be excluded as related to decrement of high-intensity physical soccer performance
- Interestingly, the research haven't found any significant relationship between peak speed during the incremental speed test and RSA test!
- **This means that they are different factors influencing match related performance, but not related to each other**
- This study is the direct support for the idea that both 'aerobic power' and RSA are important match-related factors
- This supports classification of 'work capacity' and 'metabolic conditioning' component of mine training system

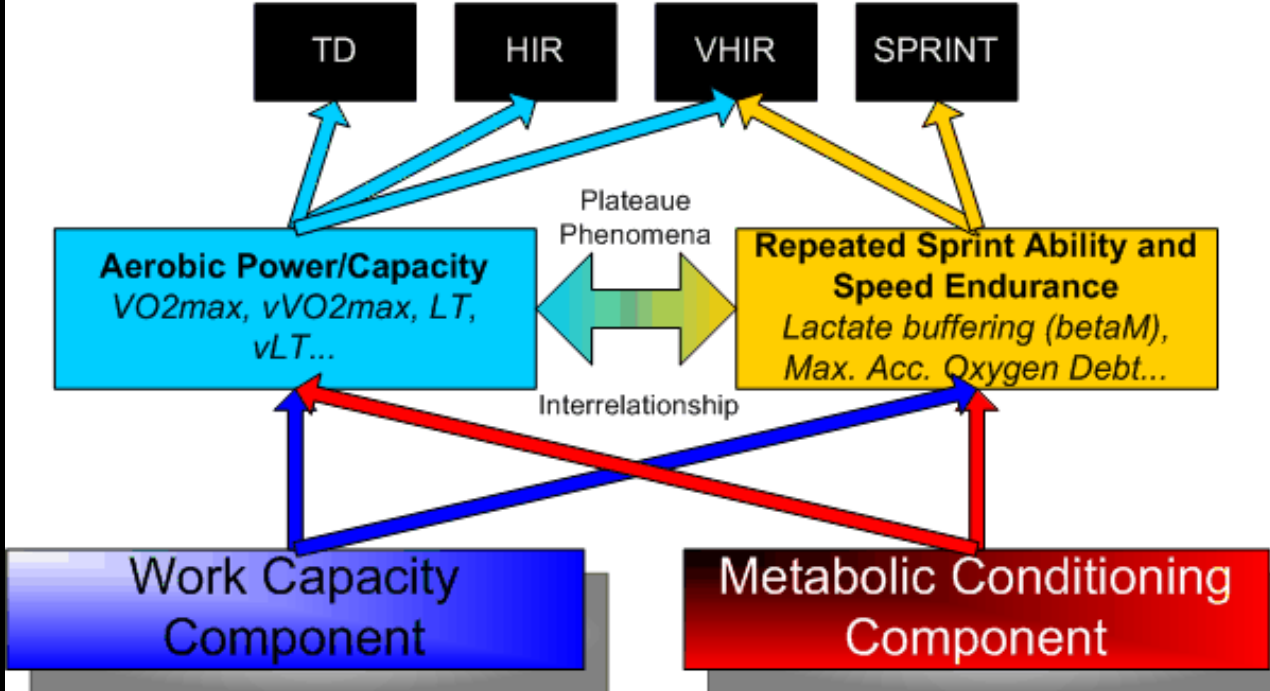
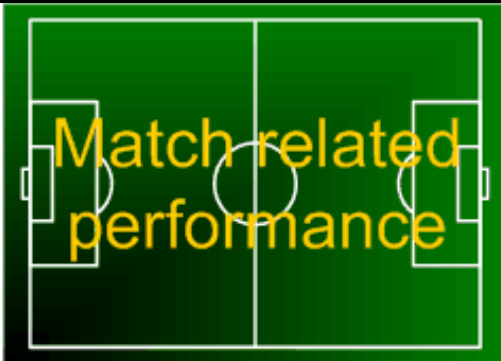

The major distinction between 'Work Capacity' and 'Metabolic Conditioning' components are (a) Intensity of the training means, and (b) Specificity of the training means

- But, are increases in distances covered (TD, HIR, VHIR, SPRINT) direct goals of training?
- **NO**, because distances covered among **physical preparedness** (ability to recover – work capacity, RSA, SE) depends also on the opponent, playing style, role/position played, situation in games, tactical/technical experience of the player etc (in other words, distances should be put into **CONTEXT**).
- The playing performance should be judged by fulfillments of tactical roles, not distance covered
- Trying to improve VO₂max as much as possible for the aim of improving distance covered, may negatively affect speed and power and ultimately **DECREASE** distance covered! Key word: **OPTIMAL!**
- The more experienced players will run less and fatigue less, because they will be on the right place at the right time (sense for the game; game intelligence)
- Now lets move to movement patterns in a soccer match...

- All the movement patterns happening in a game have their own function
- Sport movements are the example of 'serial skill' that can be broken into discrete movement patterns, each having its own function
- Jeffreys(2006) developed very usable classification of the movement patterns according to their function into three separate groups

1. Initialization movement patterns
2. Transitional movement patterns
3. Actualization movement patterns

- With 'initialization movement patterns' the athlete tries to begin or change movement, usually as a reaction to a stimuli
- This normally represents quick and sharp movement, that allows athlete to begin or change his current movement pattern
- Also, using initialization movements the athlete will try to reposition his body quickly to allow efficient performance of actualization movement patterns (quick-feet)
- The usual movement patterns that are considered into this group are: *cross-step, plyo-step, hip-turn, cut-step, chop-step...*

- With 'transitional movement patterns' the only worry of the athlete is to maintain appropriate position during which he can anticipate and react to the stimuli
- The goal of transitional movement patterns is NOT on maximal speed of execution, but rather on maintenance of appropriate body posture for quick reaction to external stimuli
- These movement patterns are usually NOT executed with great speed and effort and on long distance
- The usual movement patterns that are considered transitional are:
walking, jogging, back-pedal, low intensity shuffling and side-running...

- 'Actualization movement pattern' are usually the movements that ultimately decide about the success of movement sequence and usually includes technical/tactical element (skill) and sprint toward a given position
- Until this moment, the athlete have reacted to a stimuli and will try to come toward a given position as soon as possible, or it is going to execute some technical or tactical element
- When trying to come toward a given position as soon as possible, the athlete will start to sprint, because this is the fastest way to do it

Classification of movement patterns in soccer according to presented model by Jeffreys (2006)

Initialization movement patterns	Transitional movement patterns	Actualization movement patterns
<p>Cross-step</p> <p>Plyo-step</p> <p>Hip-turn</p> <p>Cut-step</p> <p>Chop-Step</p> <p>Repositioning of the body to allow effective performance of technical element and quick-feet for 'fainting'</p>	<p>Standing</p> <p>Walking</p> <p>Jogging</p> <p>Back-pedal</p> <p>Low-int shuffling and side running (cross-overs)</p> <p>Low-int ball dribbling</p> <p>Marking the opponent</p>	<p>Sprint</p> <p>High-int shuffles and side-running (double cross-over steps)</p> <p>Jump</p> <p>Technical elements (tackle, charging, dribbling, kicking, passing, receiving, heading, fainting, duels...)</p>

- Lets deal with 'position specific conditioning' now...
- Everyone knows that midfielders cover the greatest distance during a match, and that attackers have greatest distance covered in sprint. **So what?** Should they then run more in training, or LESS because they run so much in match?
- Does this mean we should base our workouts on 'positional requirements'? **Not in mine system!**
- The players receive position-specific stimuli during the game and game-like activities (with tactical roles)
- Why do we need to simulate the game, when we can play the game?
- We should **STIMULATE** the game and not simulate it!
- Training loads should be based on **INDIVIDUAL characteristics** (player evaluation), not position played
- The best position-specific training is **GAME!**
- The coach should fit his playing system and style toward players and not vice versa: *If you have lemons, then make Lemonade!*

- During the selection process, the athletes naturally choose and perform well at position that fits their characteristic – this is why young players should try to play all positions
- The problem 'midfielder-attacker': what if during the testing (YoYo Int Rec L1) one attacker gets a better result than a midfielder? Are they playing wrong positions? Well, we can't judge about this from testing: qualitative analysis of the match must be the priority in this situation. Are they fulfilling their tactical tasks?
- What if we put this 'non-endurance' midfielder into the group of midfielders? He will be overtrained for sure! This is why, no matter the position played, the training load should be adapted to players!
- Adapt training/playing system to players, not the players to training/playing system! (although both grow and evolve, thus this process is complex in nature)
- And for that 'endurance' attacker – does that 'not-needed' endurance negatively influence his power characteristics? Were his preceding trainings more geared toward endurance than for power and speed?
- If there is no negative transfer to speed, then this attacker may train with advanced groups, if there is negative transfer, then he can train with lower level groups and emphasis power and speed development

- The principle is 'Less yes, more never!' – depending on the situation.
- The mentioned problem 'Attacker-midfielder' is very complex and cannot be solved that easily with relations to pure numbers
- The message is that we should create groups of players that have similar characteristics and not same position played
- If the selection process is good and coach's playing system/style is based on individual characteristics, then a group of players with similar characteristics would be those that play same position, although variations are always possible and their 'nature' should be evaluated more deeply than possible in this short text
- One exception to the rule are goalkeepers!

From FIFA Manual

Position of the player	Physical qualities required	Technical qualities required	Tactical qualities required	Mental qualities required
Goalkeeper 1	<ul style="list-style-type: none"> • Size • Agility • Reaction + explosive speed • Jumping skills • Suppleness 	<ul style="list-style-type: none"> • Safe hands • Good technique on the line and in the air • Good skills with the feet 	<ul style="list-style-type: none"> • Choice of positioning and movement • Anticipation • Good distribution 	<ul style="list-style-type: none"> • Personality • Confidence • Calmness and a certain eccentricity • Concentration • A certain eccentricity
Left and right-hand-side defenders 2 + 3	<ul style="list-style-type: none"> • Speed-endurance (aerobic and anaerobic) • Explosive speed 	<ul style="list-style-type: none"> • Defensive technique • Tackling + sliding tackles • Skill at receiving the ball and good-quality passing • Running with the ball 	<ul style="list-style-type: none"> • Positioning and repositioning • Timing • Involvement in attacking play • Versatility in attack 	<ul style="list-style-type: none"> • Aggressiveness • Willpower • Confidence
Central defenders 4 + 5	<ul style="list-style-type: none"> • Height • Muscular power and jumping skills • Speed • Mobility 	<ul style="list-style-type: none"> • Interception • Control of the ball in a duel situation • Heading • Long and short passing 	<ul style="list-style-type: none"> • Anticipation • Positioning • Marking • Covering and support play 	<ul style="list-style-type: none"> • Leadership temperament • Direction • Calmness, ability to remain unruffled • Courage
Defensive midfielder 6	<ul style="list-style-type: none"> • Endurance (aerobic) • Strength (in the duel) • Mobility 	<ul style="list-style-type: none"> • Defensive technique • Passing • Receiving the ball and specific control • Dribbling the ball away for distribution upfield 	<ul style="list-style-type: none"> • Positioning and repositioning • Anticipation • Pressing 	<ul style="list-style-type: none"> • Fighting qualities • Humility • Co-operation • Willpower

From FIFA Manual

Position of the player	Physical qualities required	Technical qualities required	Tactical qualities required	Mental qualities required
Left and right-side midfielders 7 + 8	<ul style="list-style-type: none"> • Endurance (aerobic and anaerobic) • Speed 	<ul style="list-style-type: none"> • Running with the ball • Dribbling • Crossing • Shooting 	<ul style="list-style-type: none"> • Moving back to defend • Involvement in attacks • Pressing • Playing and winning duels 	<ul style="list-style-type: none"> • Courage and generosity of spirit • Willpower • Concentration • Willingness to take risks
Attackers 9 + 11	<ul style="list-style-type: none"> • Power (in the duel) • Speed • Liveliness • Agility (depending on the type of player) 	<ul style="list-style-type: none"> • Finishing (shooting) • Control • Heading • Dribbling, feinting 	<ul style="list-style-type: none"> • Constant movement • Changing of positions • Runs into space and decoy runs • Feinting • Timing 	<ul style="list-style-type: none"> • "Selfishness" • Opportunism • Tricky • Perseverance
The strategist (<i>Trequartista</i>) 10	<ul style="list-style-type: none"> • Depending on the type of player (and on the playing style) 	<ul style="list-style-type: none"> • Ability to receive and deal with the ball skilfully • Passing • Dribbling • Finishing (shooting) 	<ul style="list-style-type: none"> • A good footballing brain • Anticipation • Tactical awareness • Ability to lose a marker 	<ul style="list-style-type: none"> • Leadership temperament • Creative mind • Willingness to take risks and able to think clearly • Confidence • Calmness

- Before we deal with **player evaluation**, I will describe **Legs-Lungs-Brain analysis** method in assessing drill loads
- After that I will present my '**Conceptual Soccer Performance Model**' in one picture, and finish with '**Components of Success in Soccer**'

The Legs-Lungs-Brain Analysis Method Qualitative Analysis

Legs-Lungs-Brain are interconnected and inter-dependent variables which are 'unsplitable' in reality, but they may be used to qualitatively analyse training drills, their requirements and goals and the ability of the athlete to fulfill these goals. Based on the Legs-Lungs-Brain analysis one may classify the training drills based on the goals and the loads placed on the athletes. If one compares the drill requirements with the athletic fulfillment of the same, training modifications and decisions can be made. For example, if the drill demands for quick execution of the soccer techniques with very little metabolic demand, but the athlete shows 'flat behaviour' and 'heavy legs' with great amount of metabolic activity the drill should be stopped or modified because it doesn't fulfill determined goals.

'Legs' refer to the training intensity or the quality of the effort. The speed of the movement, number of sprints, tackles, dribblings, body-checks, jumps, shootings and other high-intensity elements determine the 'legs' component. Look at the quality and the 'ease' of effort of the players inside the drill/game.

The Legs-Lungs-Brain Analysis Method Qualitative Analysis

'Lungs' refer to the metabolic demand of the drill. Metabolic demand depends on the drills intensity ('Legs'), duration, work-rest ratios, intensity and duration of low/medium intensity activity etc. When trying to qualitatively assess the 'Lungs' component, one should look at breathing patterns of the players. Are the athletes heavily breathing, putting their hands on their knees? Look at the sweating amount cause this depends both on outside temperature and metabolic demand. Monitoring tools such as HR measurement, bLA measurement can be used as quantitative method but only as an addition to qualitative analysis, cause they depend on numerous factors. Look at the performance/athlete not HR!

Various 'zones' regarding HR and bLA can be created – this can be useful in classification of small-sided games for the sake of providing base for progression, but one should ask himself whether HR and bLA logic from continuous type activities can be transferred in HIIE activity like the soccer? Maybe as an additional tool, but nothing more - Coach's eye (sense) is the best method!

The Legs-Lungs-Brain Analysis Method Qualitative Analysis

'Brain' refers to the decision making done by the players. Involvement with the ball, 'density' of the players at a given playing area, tactical requirements/tasks determine 'Brain'.

As already mentioned, Legs-Lungs-Brain are interdependent variables. The increase in 'Brain' may require greater intensity and effort, thus this may lead to increase in 'Legs' which may result in the increase in 'Lungs'. Various game/drills parameters may determine the Legs-Lungs-Brain requirements, like playing size, number of players, zones, rules, tasks, number of touches, tactical requirements, technical requirements, duration, instructions, reinforcements etc. Anyway, the discussion of this issue is not the aim of this text.

Various forms of fatigue and other factors may affect the athletes performance in the games and thus Legs-Lungs-Brain analysis and the fulfillment of the game/drill requirements. The 'art' is to identify these factors, modify the game, to plan/program the training process to address them effectively. Some hypothetical situations can be found in the following table.

The Legs-Lungs-Brain Analysis Method

Qualitative Analysis

Drill/Game requirements	Athletic Performance	Possible reasons
Great 'Legs', great 'Lungs', great 'Brain'	Great 'Legs', great 'Lungs', low 'Brain'	Lack of tactical preparation, demotivation, perceptual/emotional fatigue, low technical skill
	Great 'Legs', low 'Lungs', low 'Brain'	Athletes 'spares' themselves, don't want to run and reposition themselves
Low 'Legs', low 'Lungs', great 'Brain'	Great 'Legs', great 'Lungs', great 'Brain'	Over-motivation of the athletes. Lack of proper instructions
Great 'Legs', low 'Lungs and 'Brain'	Great 'Legs' but heavy 'Lungs'	Out of 'shape' (lack of aerobic preparedness)
	Poor 'Legs', low 'Lungs'	CNS fatigue, demotivation to train, depletion of muscle glycogen, improper training methods (LSD runs), lack of speed and power
	Poor 'Legs', heavy 'Lungs'	CNS fatigue, out of 'shape', lack of speed and power

The examples in the table are only hypothetical. Please note that there are many combinations and even more reasons for discrepancies between game requirements and athletic performance. The coach must identify the reasons and address them. This is why coaching is an art more than a science.

The Legs-Lungs-Brain Analysis Method

Qualitative Analysis

The coach can classify all of his training drills according to their objective/goals and reactions they cause to the athletes. He may use HR, bLA etc, but if he lack those, he can use proposed Legs-Lungs-Brain Method. Every drill can have scores from 1-5 on Legs, Lungs and Brain characteristics

This example is mine attempt to do that for couple of training drills/types

Training Drill	Legs	Lungs	Brain
Tempo run	3-4	4-5	0
Speed session	5	0	0
Tactical training (submax)	3-4	1	3-4 (due lower intensity)
Tactical training (max)	5	2-3	5
Technical training	5	2-3	2-3
10on10 ½ of the field (the game of speed and reaction)	5	1-2	4-5
2on2	5	5	2-3
4on4	5	4-5	3
Recovery ball tennis	0-1	0-1	0-1
Game	4-5	4-5	5

Conceptual Soccer Performance Model

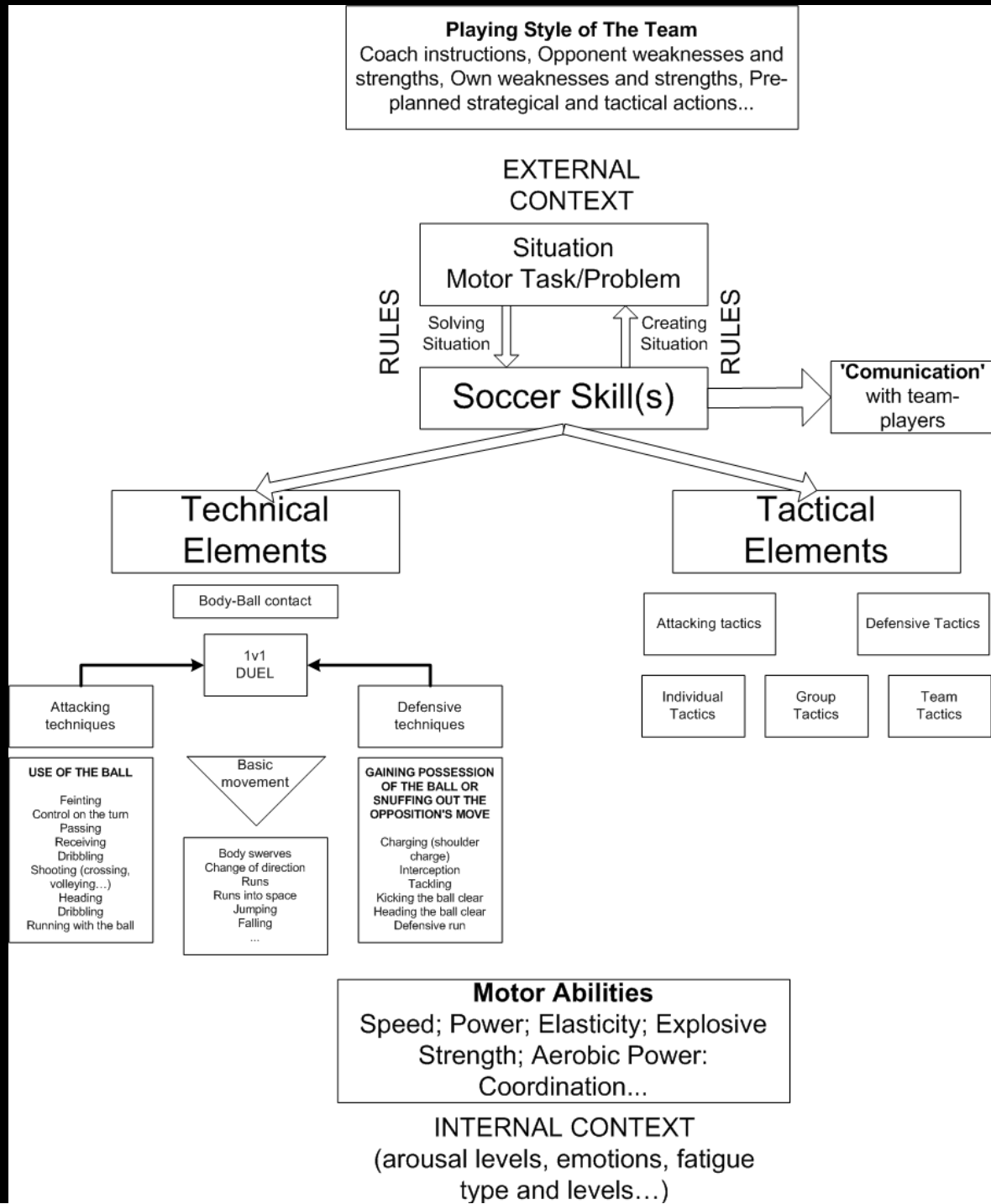

Components of success in soccer

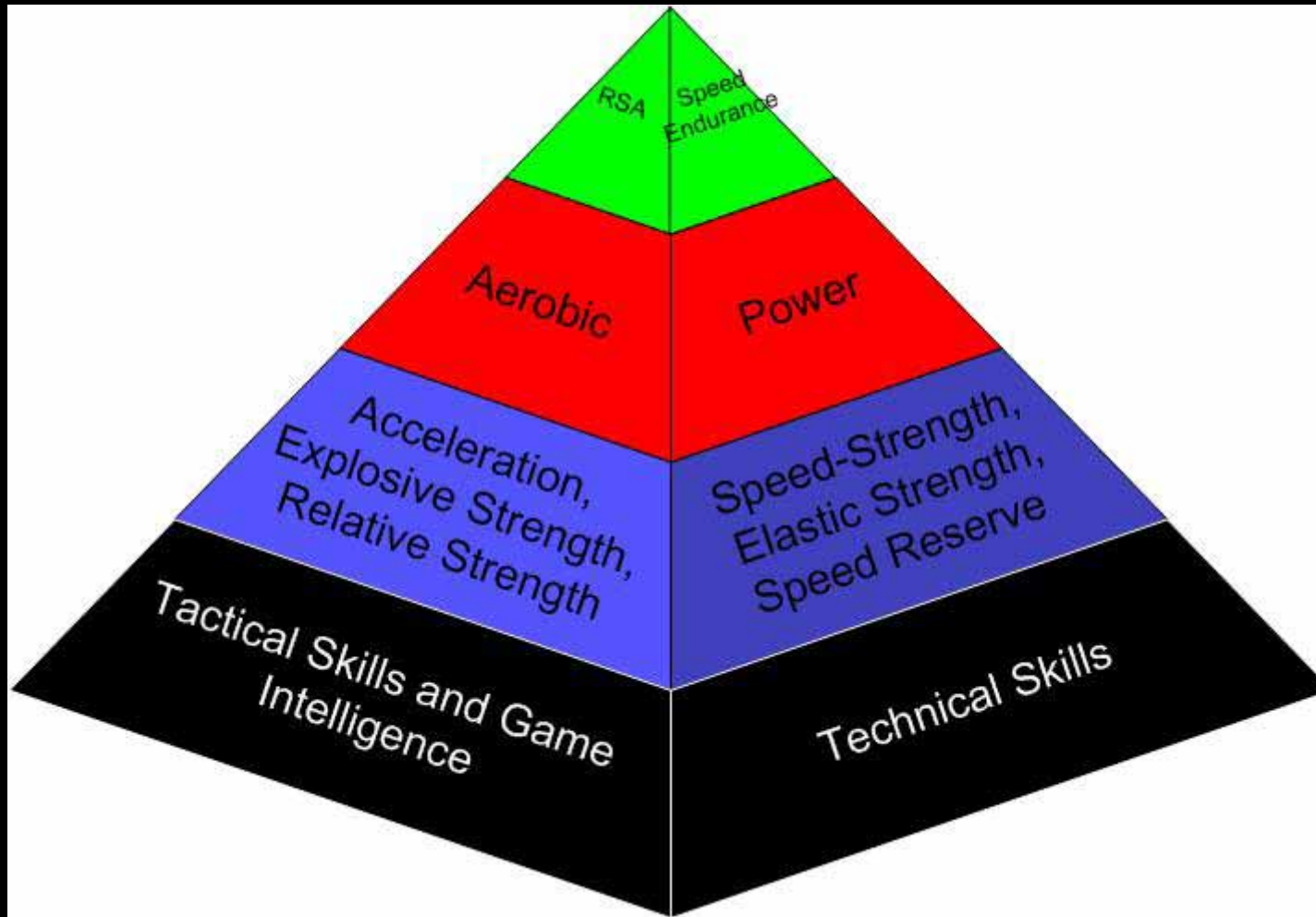

Athlete Evaluation

- Evaluation of the players is a process of determining player's **strengths** and **weaknesses** and determining training actions to address them (*what should be done with a player to enable him to play better or progress and develop*)
- It is very hard to tell what is player's strength and what is his weakness! The coach should be very careful in determining these two
- For example, if the measurements show low aerobic power of the player, is this his weakness? What if the player is very explosive? What if the coach tries to 'address' his weakness (low aerobic power) and screw his strengths (explosiveness)?
- **Don't lose sight of the forest for the trees!**
- Thus the evaluation is very complex and should be based on qualitative (watching the player play) and quantitative (doing tests) aspects
- Evaluation is also multi-level – it can be psychological evaluation, physical, technical, tactical, etc, etc.
- We are going to deal with **evaluation of the physical preparedness** of the athletes

- **Physical preparedness evaluation** is a process of assessing physical preparedness and making training decisions regarding appropriate actions that should take place with the objective of improving players performance
- Or in another words, evaluation should **identify 'limiting factors'** that limit physical preparedness of the players
- Physical preparedness evaluation can be also **qualitative** and **quantitative**. Qualitative is about observing player move, observing his technique of running, change of direction etc, etc, while quantitative is about testing the athlete.
- Quantitative evaluation of physical preparedness can be divided into following groups
 1. Evaluation of strength/explosive strength/elastic strength
 2. Evaluation of acceleration/speed/change of direction
 3. Evaluation of aerobic power/RSA/SE
 4. Evaluation of 'structural' characteristics (body proportions, assimetries and imbalances of muscles...)

- **Evaluation of strength/explosive strength/elastic strength** is determining players strength, his ability to use that strength both in explosive action and elastic actions
- The purpose of this evaluation is to assess the following characteristics of the athlete:
 1. **Force or Strength**
 2. **Rate of force development (conscious)**
 3. **Reactive strength (unconscious, reflexive)**
- This way the coach can tell what the athlete lacks and how to improve it
- The squat is an assessment tool for Strength, and the goal should be to squat parallel about 1,5-2,0 BW. Until that time the athlete should aim to increase his strength at squat, after this point the emphasis should be geared toward improving his power clean toward 1,1-1,4 BW
- More Strength and Strength-Speed norms can be found in **Al Vermeils** manual

- Voluntary explosive strength and reactive strength are independent components of motor function. That is, athletes can be really good at one and not the other but both are trainable. (Kelly Bagget)
- Athletes that are good at explosive strength tend to have great acceleration, but lacks maximum speed. They are also good at jumping from two legs (deep knee bend).
- Athletes that are good at reactive strength tend to have great maximum speed and jumping ability from pre-run and from one leg.
- We can thus differ between two types of athletes:
 1. Powerful athlete
 2. Elastic athlete
- Each of these two need different training to improve even further. Powerfull athlete need more plyometrics training ('FLAT'), while elastic athlete needs more strength and explosive strength training ('UP' variations of plyos)

- Thus the purpose of evaluation is to indentify these two types of players
- We can do this by comparing
 1. Squat jump (SJ) and counter-movement jump (CMJ)
 2. Counter-movement jumps and depth jumps from boxes with increasing heights
- The relation between CMJ and SJ is calculated in the following way:

$$\frac{CMJ - SJ}{CMJ} \times 100$$

- If the result is more than 10%, then the athlete needs to spend time in improving strength and explosive strength, and if the difference is less than 10% the athlete should spend more time improving his elastic strength with the use of plyometrics

- The second test is based on comparing the ordinary jump (CMJ) which is more 'strength oriented' and depth jumps from increasing heights which are more 'elastic oriented'
- The athlete should do the CMJ and measure its height
- Second, the athlete should jump from 12inch box and measure the height. If the height is lower than CMJ then the athlete should stop the procedure, if it is not, the athlete should continue to increase the box height for 6inches until the depth jump is larger than CMJ.
- The results may be the following:

Athlete A	Athlete B	Athlete C
Vertical Jump: 24 inches Jump from 12-inch box: 22 inches <u>Needs:</u> Reactive strength and speed work	Vertical Jump: 32 inches Jump from 12-inch box: 33 inches Jump for 18-inch box: 35 inches Jump from 24-inch box: 36 inches Jump from 30-inch box: 38 inches Jump from 36-inch box: 34 inches <u>Needs:</u> Strength	Vertical Jump: 28 inches Jump from 12-inch box: 29 inches Jump from 18-inch box: 30 inches Jump from 24-inch box: 27 inches <u>Needs:</u> An overall mix of Reactive strength, explosive strength, and Limit Strength work

* Taken from Kelly Bagget's 'Vertical Jump Bible' book

- From this test, the coach can indentify the type of the athlete, along with the optimal height for depth jumps (the one where the height is largest)
- If athlete's vertical jump off the boxes is 20% or more greater than the squat jump, he is very efficient plyometrically and will probably make further improvements by focusing on building up strength through heavy weight training. If his regular down and up jump is fairly even with his depth jumps, his reactive strength is lacking so he should focus on plyometrics in training. Those who have very well developed reactive ability will find their best jump is off a higher box (>18 inches), and they are probably fairly strong as well as plyometrically efficient. (Kelly Bagget)
- This way, during the **Strength & Power Block**, we can say what type of work the athletes need to emphasise: strength training (squat, DLs, etc), strength-speed training (Olympic lifts), explosive strength training ('UP' variations of plyos, jumps squats, oly's too) or reactive strength ('FLAT' variations of plyos)

- Another option to assess whether the athlete is more powerful or elastic is to compare CMJ and repeated jumps for 15sec, where the height of the jump is calculated, the duration of ground contact (GCT) and power index (height/GCT)
- Yet, another option is to compare two legged-jump (CMJ) with unilateral running jump
- The coach has numerous options to assess whether the athlete is more powerful or elastic. Observing the athlete runs, cuts, jumps and his body-build can tell a lot too
- The important thing is to identify what limits the athlete: strength, explosive strength or elastic strength. How the coach will do this is his choice!

- **Evaluation of acceleration/speed/change of direction** is about assessing the ability of the player to use his linear speed in agility tasks, also determining whether the athlete needs more speed work or strength work
- To do this we can compare the straight ahead linear speed with a test that requires change of direction
- To assess linear speed we can measure 30m run with 10m measured too
- To assess change of direction, we can use numerous tests, like zig-zag run, zig-zag with the ball (this way we can tell how good the athlete's ball handling skills are too), 20-yard agility run, etc, etc
- Comparing these two tests, the coach can tell how much linear speed the athlete is able to use in change-of-direction tasks, and decide whether the athlete needs more linear speed or lateral speed and change-of-direction work, although **I question whether this has any transfer to field performance** (see Speed Work Component)!
- Also, if athletes show great speed but lack strength, they should be classified 'speed dominant' or 'strength dominant' if they squat much but can't utilize their strengths in sprints

- Comparing the results on various distances can tell whether the athlete is more powerful or elastic, too!
- The evaluation should not be something too much scientific! The coach should pick some tests and track their results over time, their relations and correlations and build his own database from which he can learn and decide appropriate actions.
- But one should be remembered: **watch the athlete, not the numbers!** Numbers are there just to help the coach's qualitative analysis.
- This topic is very large and cannot be described in full detail here – every coach has his own methods, this is why coaching is more art than a science!

- **Evaluation of aerobic power/RSA/SE** is about assessing aerobic power of the athlete, RSA or SE and deciding what type of work the athlete needs to emphasise to improve his field performance
- Various criterias and norms can be created over time and with coaching experience for all types of evaluation, including this one too.
- For example the coach can know wheather the athletes are ready to play if they manage to run a given tempo workout without too much fatigue, etc
- To assess aerobic power I love to do YoYo Intermittent Recovery Test
- To asses RSA there are numerous tests that can be used, but I pick 6x40m (20+20m) with 20sec of passive recovery
- To assess SE, 300yard shuttles can be used (2x300yard w/1min recovery), but I would rather use 6x20m shuttles back and forth, for example, repeated for 2 times with 1min passive rest
- The goal is to pick some test, track their results over time, compare each other, correlate each other etc, and with experience decide what training action should take place!

- **YoYo Intermittent recovery test** is better to use than 12-min run, or laboratory measurement of VO₂max, cause it is more 'specific' to soccer.
- It is shown that the distance covered in YoYo test correlates well with VO₂max, LT, distance covered during a match etc, etc.
- Also, the speed at which athlete exhaust can be used to program interval aerobic training like tempo (work capacity component)
- **Using the results of the YoYo test, the coach can create groups of athletes with similar aerobic power and thus create more 'individualization' in training**
- One solution is to calculate Z-numbers for each player (number of standard deviations that result differ from mean value), group the players with similar values (for example: group A: -1 to 1; group B: smaller than -1; group C: larger than 1)
- So when doing tempo work, the athletes with better result can cover greater distance or have shorter rest between the reps, for example
- Usually, the groups would consist of players playing the same/similar position, but exceptions to the rule are possible

- **RSA test** that I pick is 6x40m (20+20m) with 20sec passive rest
- The result from this tests are mean sprint time, total sprint time, fatigue index etc, etc
- The purpose of the test is to assess RSA abilities of the player
- With this information we could again make groups of players having simillar RSA abitilies when doing RSA training (without the ability to measure sprint time and determine *threshold of quality*) – thus, the players with better RSA can have shorter rest or do larger number of reps per set
- Another information can be gained when comparing the result with YoYo test – if the athlete have good YoYo result, but lacks RSA he should spend more time developing RSA, if both RSA and YoYo results are poor, the athlete should spend more time doing Work Capacity Training and improving aerobic power
- We could also compare the results with linear speed tests, and decide whether the athlete needs more speed work or RSA!

- **SE test** that I pick is 6x20m shuttles, repeated for 2 times with 1min recovery
- The results from this tests are total time, average time, best time, fatigue index (decrement)
- This test may be done and may not be done, depending on the time that coach have, altought it would be interesting to compare the results of this test with another tests
- I couldn't find the correlations with the YoYo-SE and RSA-SE tests and SE-30m run test, altought this would be interesting to have
- The results can be used to create groups of playerswith simmilar SE abilities

- It should be noted that evaluation is a **COMPLEX** process that shouldn't be based on numbers but rather helped with numbers!
- In mine system the following test battery can be used

Strength tests:

1. Squat
2. Power Clean
3. Bench Press/Military Press
4. Pull-Up

Speed Tests

1. 30m run (with 10m)
2. Zig-zag run (or 20-yard agility run test)
3. Zig-zag run with a ball

Power-Reactive tests

1. Vertical Jump
2. Depth jumps for increasing boxes

Aerobic power/RSA/SE tests

1. YoYo Intermittent Recovery
2. 6x40m (20+20m) w/20sec rest
3. 6x20m shuttles w/1min rest

- Evaluation of 'structural' characteristics tests are very important, but not usually done!
- The goal of these tests is to assess body composition, muscle imbalances (that may cause troubles and limit performance), assimetries in limbs (like comparing SL tripple jump in left and right leg with ACL rehabilitate athletes for example), core stability, flexibility, mobility, etc, etc
- Altought very important tests, they would not be considered in futher detail here!

- **To summarize....**
- Evaluation is about finding athletes 'strength' and 'weaknesses' that determine his performance, finding those factors that limit his strengths and increase his weaknesses and determining training actions that should address them
- Evaluation is very complex process and also multi-leveled (technical, tactical, physical, psychological...) which cannot be done solely by testing, but it is rather helped with testing and based on qualitative assessment of experienced coach
- Soccer match is the best test there is!

Training System

- **Athlete Preparation System** is more than the sum of its components, but represents their integration and synergy
- Athlete Preparation System consists of: (a) **Training**, (b) **Competitions** and (c) **Recovery**
- In this presentation we should deal with Training System, as one component of Athlete Preparation System, although we will deal with Competitions (in-season planning, friendly games etc) and Recovery (nutrition, recovery means, etc) components too
- All the components of the Training System are inter-connected and inter-related
- To reach defined goals/objectives, individual training components should be intergrated into 'wholistic' training system

- The goals of the Training System are the following
 1. To reduce possibilities for injury both on competitions and training sessions
 2. To improve athlete's performance on the field
 3. To enable optimal preparedness at a specific time frame – period; Development of the 'sport form'

- Proposed training system consists of the following Components:

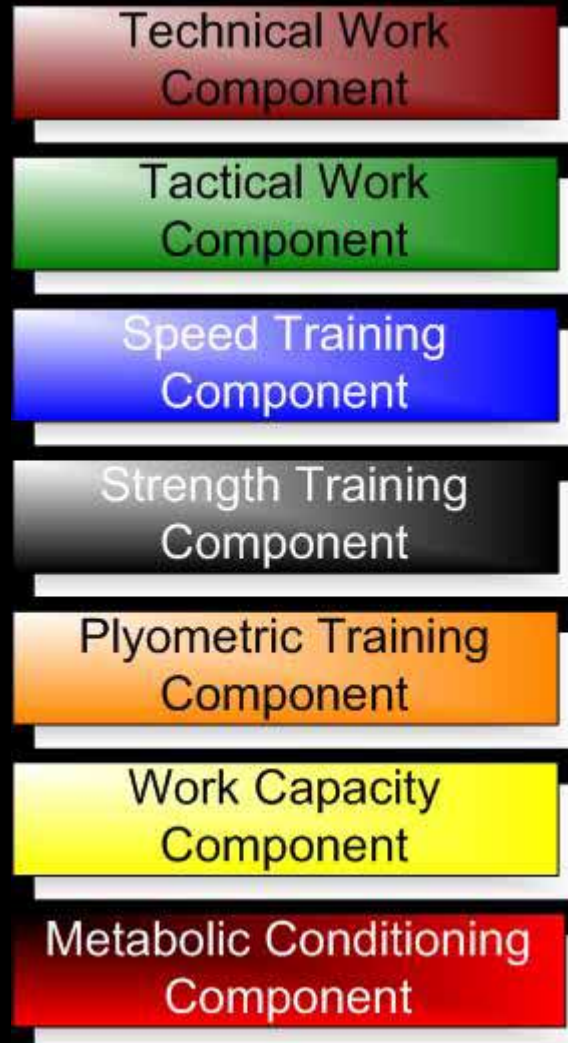

* It is very hard to 'draw a line', which means that there are overlappings between the components!

- For the system to function, components should be integrated
- Traditional wisdom (periodization) suggests that the components should be developed SEQUENTIALLY, starting from a build up of volume and then later intensity of the training

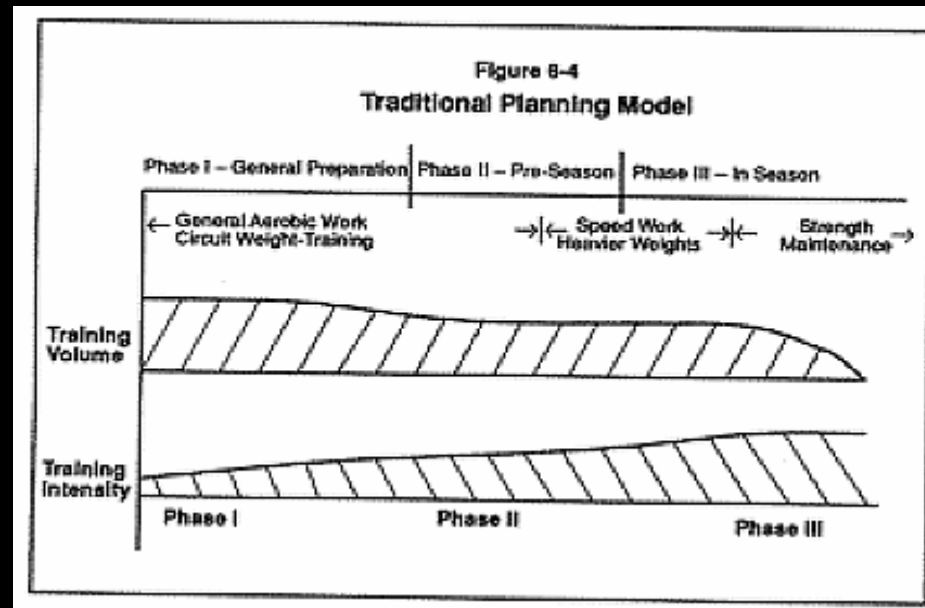

* Taken from Charlie Francis Training System book

- This represents potential problem from many reasons
 1. It is imposible to 'intensify' the training continuously over time, namely increaseing the volume of high-intensity components, which will result in endangering athlete recovery capacities. To allow futher 'intensification' the volume of high-intensity components should DECREASE
 2. By the law of 'Use it or lose it', the traits that are not being trained de-adapt and fall down. In the given example, when it comes to speed to be developed, preceding strength levels will fall down and disable optimal speed development
 3. Every sudden change in the structure of the training impose a potential danger from injuries. The example are the sudden jump from strength training block to plyometric block. Everytime the athlete changes the objectives of training, he is threat by experiencing 'adaptive stiffness' (Charlie Francis)

- According to new model, the intensity must be present from day one, but its volume varies from phase to phase

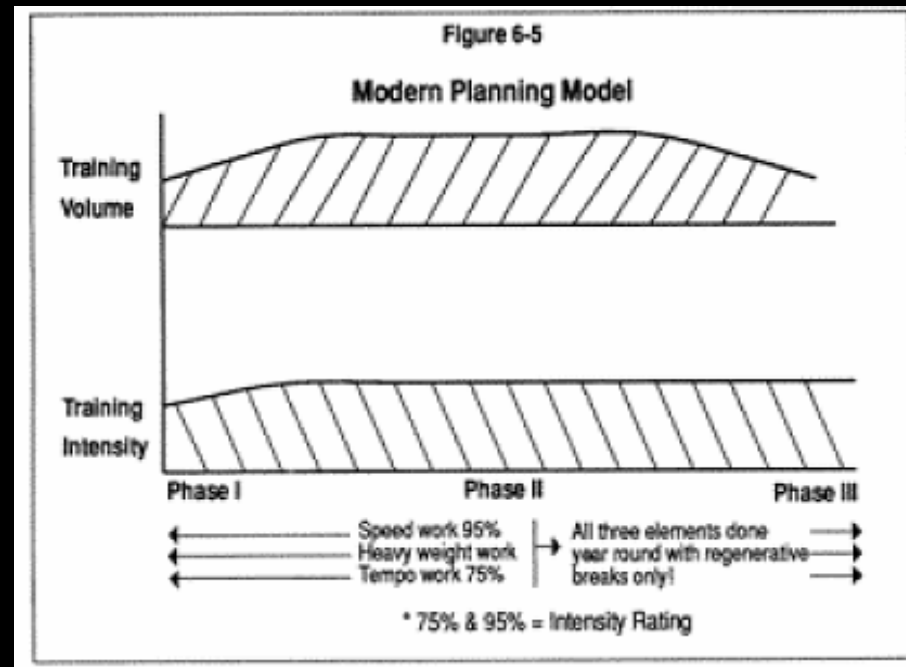

- One of the possible solutions for sequential or traditional approach is to develop all training components at the same time (*microcycle*)
- This is called CONCURRENT periodization
- In concurrent periodization, all training components are being developed in one microcycle

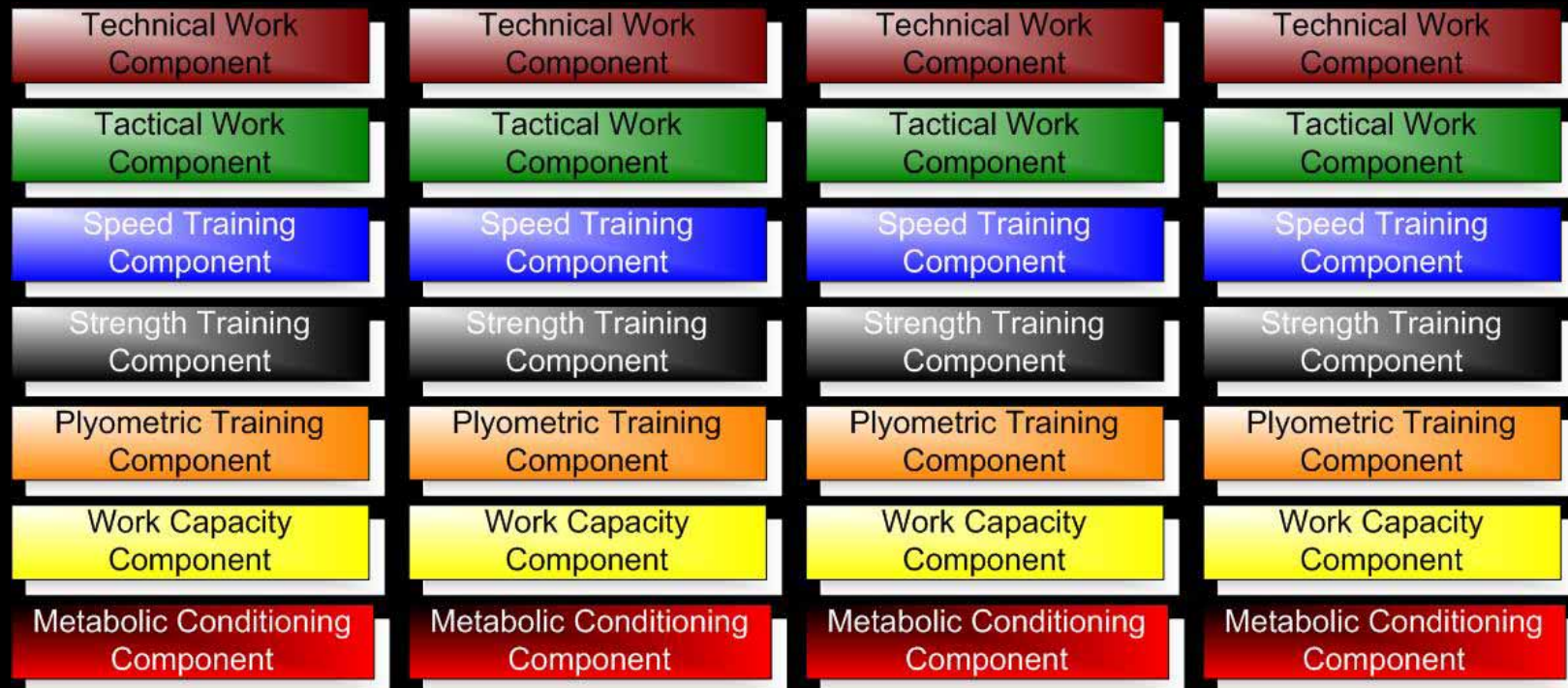

- Problems that arise in concurrent periodization are the following
 1. Advanced athletes are unable to adapt to large number of different stimuli at the same time
 2. If all components are being developed, the athlete will be fatigued and threat by developing over-trainign syndrome
 3. Some components require SEQUENTIAL development, like Work Capacity Component and Metabolic Conditioning Component; before you are able to repeat or prolong high quality effort you must have that quality in place at the first time
 4. More components that should be developed means more time spent in training
- Sometimes the preparatory period is so short that concurrent periodization is a optimal choice for such short period
- Also, concurrent periodisation is optimal choice for in-season planning, but components are not being developed, but rather maintained (more on in-season planning later)

- **SOLUTION:**

1. Combining both sequential and concurrent training methods
2. Development of components in sequential manner, while maintaining non-emphasised components with minimal volume of work
3. This is called 'Vertical Integration' (Charlie Francis) or 'Conjugate Sequence System'

- By the usage of Conjugate Sequence System (CSS) we use merits from both models and avoid their shortcomings
- Athlete trains all components concurrently, while sequentially emphasising one or more components, and changes emphasis over time
- Emphasis represents time, volume or intensity which are used during the development of particular component
- The relative emphasis between components and its 'switching' is more the art than it is a science!

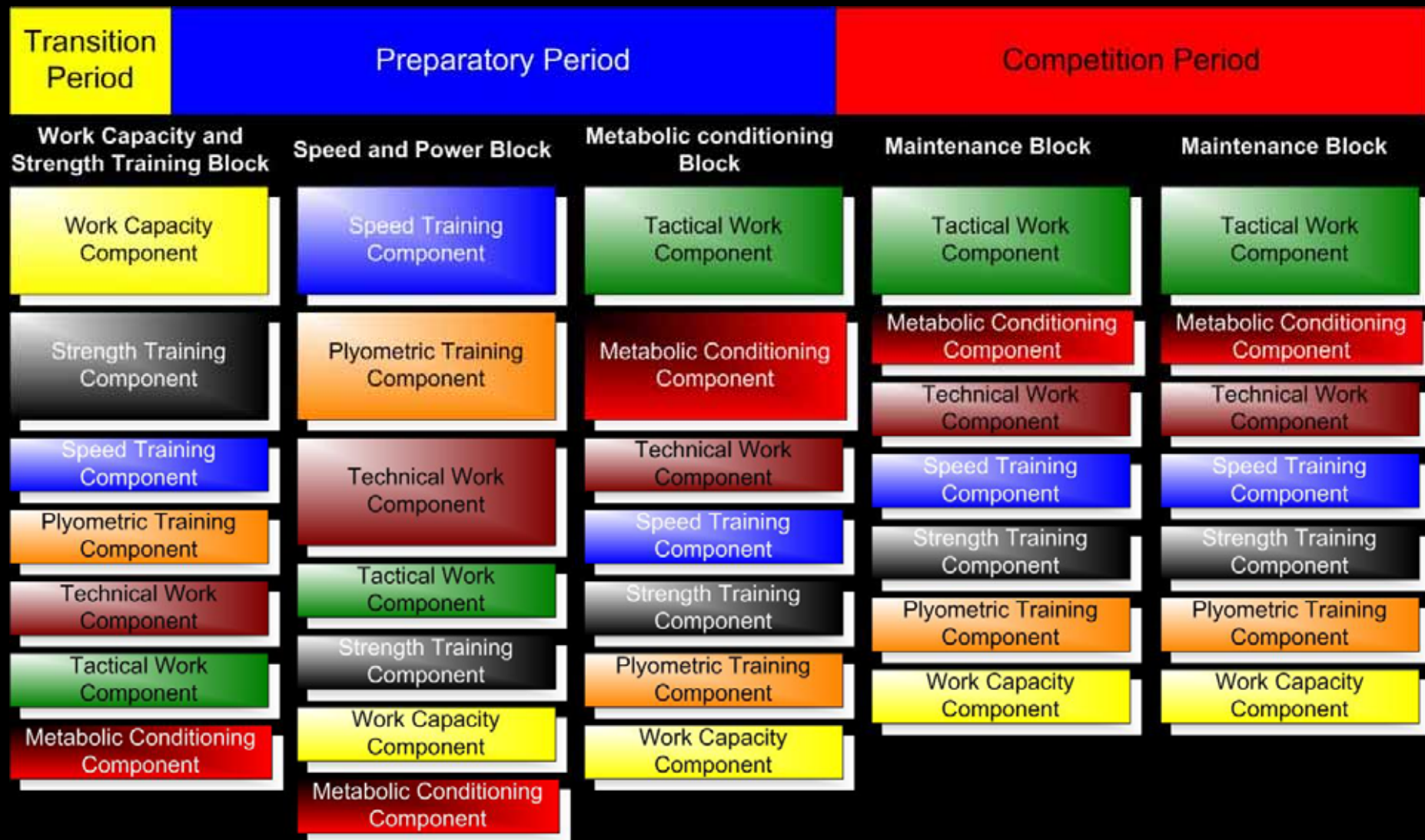

- The concrete design of the training year depends on the:
 - (a) objectives and goals of training periods, year cycle;
 - (b) evaluation of the athletes, age, experience, etc;
 - (c) context, like competition calendar, facilities, weather etc.

- Development of the 'sport form'

- Sport form is a state of optimal preparedness for sport achievements which athlete acquire with adequate preparation on each new level of sport perfection (prof. Vladimir Koprivica)
- To be in the state of sport form, and to be in it at the right moment, is the single most important task that should be solved during the training process by both coach and athletes
- The basic criterium by which sport form can be evaluated is the result in competitions. Competition is the best test, because in it all components of the sport form are being integrated
- There is a distinction between individual sport form and team sport form. **Team sport form is more than the sum of individual sport forms. Team is NOT the collection of the best individuals, but collection of the individuals that best function as a team**
- The coach must qualitatively assess and evaluate if the team is in the state of sport form, because there are no numerical test for it!
- Planning of the training must be guided by the laws of sport form development and by competition calendar

- High level of preparedness (technical, tactical, physical, psychological) is the basic requirement of the sport form
- Although sport form is NOT the level of preparedness – it is more than that!
- Sport form is the state of ‘harmony’ of components that builds her (mentioned types of preparedness)
- That ‘harmony’ is achieved via competitions and usage of competition means and loads

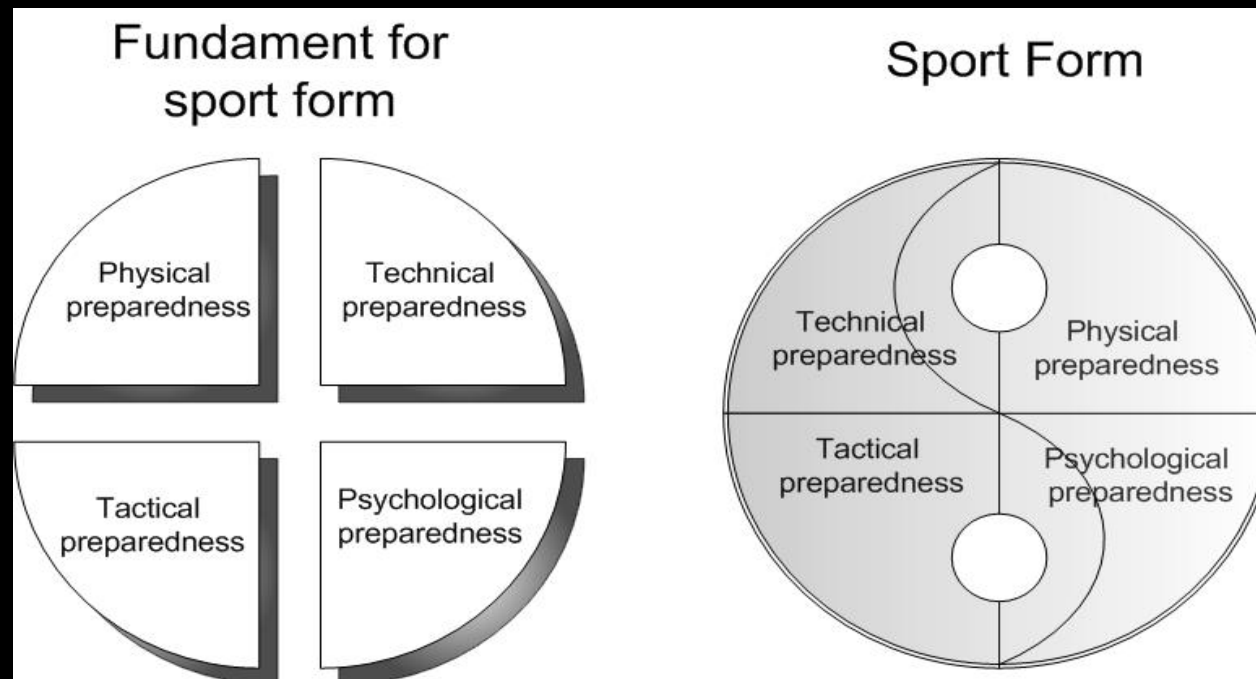

- Sport form exhibit 'phasical' characteristic with three distinct phases
 1. Phase of entrance into the sport form,
 2. Phase of maintenance (relative stability) of sport form and
 3. Phase of temporary loss of sport form

- Phase of entrance into the sport form correspond with preparatory period. During this phase the emphasis is on the development of fundament, from which quality of the sport form depends. At the beginning, in most cases, there is a separately development of physical and technical/tactical qualities of the athlete, but with progression they are more and more incorporated into competition exercises. Phase of entrance into the sport form lasts differently and it is often determined/dependent on the **competition calendar**, but also with **biological basis** of development of her components and their integration
- Second phase of sport form usually coincide with competition period. Sport form can last for about 2,5 months (2 months + ½ months with special 'refreshment'). Sport form does not exist without competitions, but at the same time competitions 'spend' sport form
- Sport form is impossible to keep for a prolonged period of time, thus it must be 'break-up' and re-built again to avoid overtraining, mental fatigue and allow further development of the athletes
- More on Sport Form can be found in the following [article](#)

- Because competition period lasts long (about 3 months), it is impossible to maintain sport form which can be maintained only for 2 – 2,5 months, so different player (playmakers, key players) are introduced into sport form at different times so that the competition period could be qualitative covered.
- Other solution is to use first 1/2 month of competition period to enter sport form (*srp. uigravanje*), and to use last 1/2 month of competition period to maintain sport form by 'refreshing' players with various methods (which are going to be covered later).
- Offcourse, the selection of appropriate method depends on quality of a team and the competition calendar. The best situation for some good team is to play games with poor teams in the first 1/2 month of competition period and to use this to enter sport form. They will win them were they, or not, in the state of sport form. Also the poor teams can use same method to enter sport form but they will play with good teams because were they, or not, in the sport form they will lose the game. This depends only on the competition calendar and the goals settings, so coach should adapt to allow reaching the highest goals. Don't forget that some games should be lost to allow some games (most important) to be won!!

- Reaching, maintaining and 'breaking-up' of sport form is controlled by the **ratio of general and specific preparations**, or the volume of general, specific and competitions means

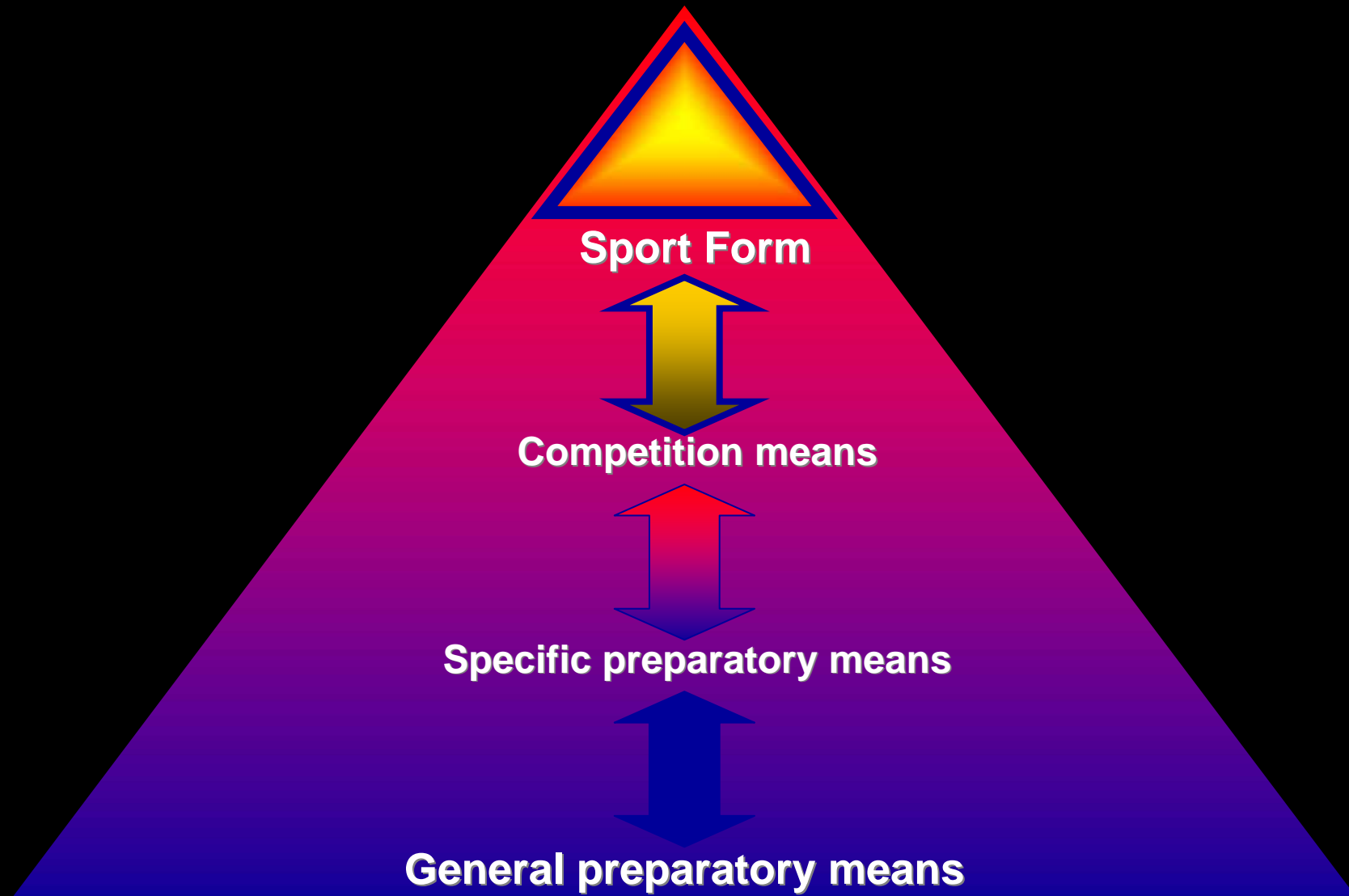

Sport Form Development

General Preparatory Means

Specific Preparatory Means

Ratio of general and specific preparation

Specific Preparatory Means

General Preparatory Means

Preparatory

Pre-Comp

Comp

** Modified according to James Smith's SSS Presentation*

- As mentioned earlier, the ratio between general and specific preparation controls reaching, maintaining and 'breaking-up' of the sport form
- From this reason, coach must classify means as general, specific and competition in **every training component** and to plan their relation for the sake of controlling the sport form of the athletes and the team

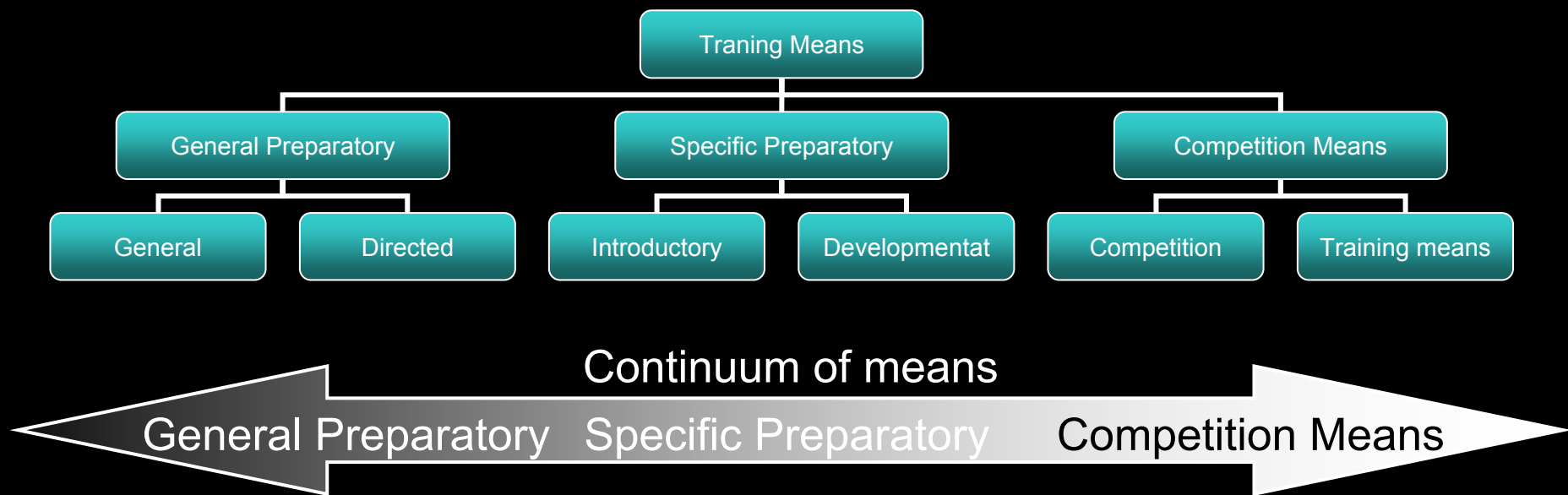

- The whole point about this is, along with working concurrently all training components and emphasising one or more of them during certain periods, relation between general and specific means used in each training components should vary during the year cycle, to allow control over the sport form!

- Both general and specific preparation are always present in training at any stage
- Their **RELATION** varies during the year cycle and athlete's career
- **Some training components consists of all three training means, while some have one or two types of training means**
- General Preparatory Period (GPP) and Specific Preparatory Period (SPP) differs by training objectives and by ratio between general, specific and competition means
- General Preparation is necessary for the reason of achieving
 1. **Multilateral development**
 2. **Formation of fundament of sport specialization**
 3. **Active recovery**
 4. **Breaking-up of monotony**
 5. **Purposelly breaking-up of sport form**
 6. **Preventing or reducing effects of factors that may lead to injury**
 7. **Introducing athletes to training process**

- Similar to management principle of **Production/Capacity of Production** (**Stephen Covey** – *7 habits of highly effective people*), specific means secures short-term results and Production, while general means secures long-term development and Capacity of Production, or a 'base' for long-term production
- In training we must produce results, but at the same time we must secure a base for continuous results to come
- If we concentrate on fast results (and specific preparation only), we are going to have short-lasting athletes with a lot of injuries and plateau in performance
- If we concentrate on long term results only (using only general means, rehabilitation, etc) we are going to have healthy athletes but there are not going to be results
- Thus, both should be present constantly and variably over time
- We should prioritize things that are important but are not urgent

- General preparation must be **specialized!**
- Although this sounds contradictory, it is necessary to prevent 'negative transfer' of general preparation and the decrease of training effects
- The example of this situation is the usage of long slow distance (LSD) running for building of 'aerobic base' with soccer players. Although this base will be formed, prolonged LSD running will **NEGATIVELY** affect explosive characteristics of the players which are more important and harder to build
- In relation to this, general preparation must secure mentioned seven tasks, but without negative transfer and decreasing of effects of specific preparation
- There is time and place for everything!

How is this going to prepare you for...



This ????

* General preparation must be **specialized**, both from Energetical aspects and Biomechanical aspects!



High-Low Planning (Charlie Francis)

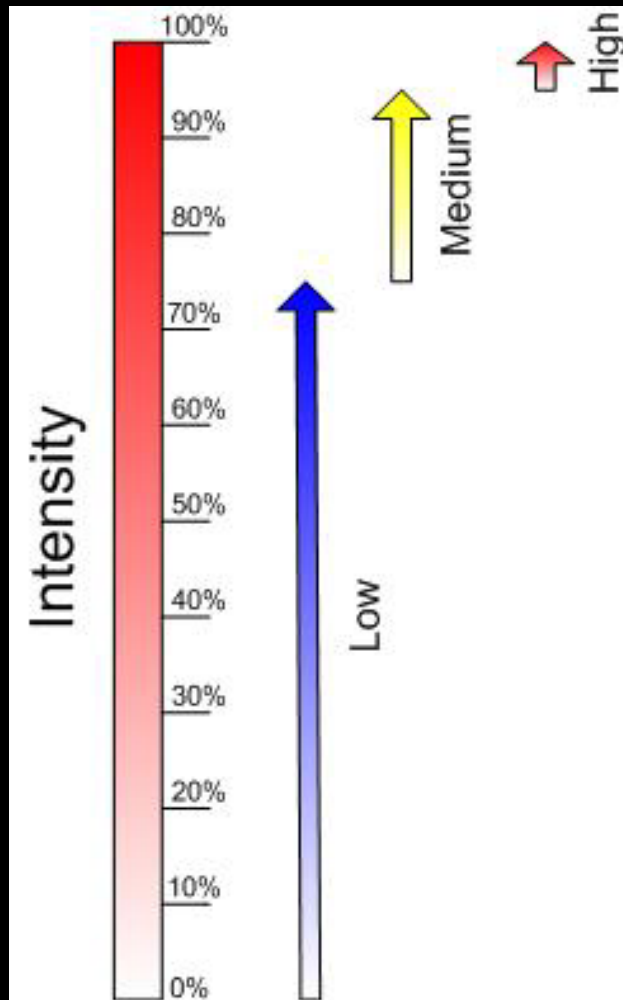

High-Intensity means (HI: 95-100%) - Increased acceleration & speed; increased power output; increases muscle fiber recruitment; requires complete recovery due to Central Nervous System (CNS) fatigue; minimum 48 hours recovery.

Medium-Intensity means (ME: 75-95%) - Too slow for speed development and too high of an intensity to be specific to aerobic development. Training in this area often falls under speed endurance or special endurance, which is non-specific to the game. This training requires unnecessary additional recovery time and will likely take away from the qualities which are specific to the game.

Low-Intensity means (LO: 75% or slower) - Aids in speed enhancement through an increase in capillary density (heating of motor neuron; less electrical resistance); prevents fatigue through the buffering of lactate during exercise; increased recovery between high intensity movements by increasing blood flow to the working muscles for nutrient delivery and waste removal; increased cardiac output; may also aid in ATP resynthesis between bouts of high intensity movements (Vass); low intensity allows for recovery within 24 hours.

- Although mentioned **High-Low system** is related to running speed, classification of activities on HI, ME and LO with relation to **fatigue they develop** is used extensively in mine system
- **HI activities** cause 'CNS Fatigue' (or High Intensity Overreaching) and demand fully recovered athlete for training session, and takes about 48h of recovery
- **ME activities** cause 'Metabolic Fatigue' and may also cause 'CNS Fatigue' due their great intensity. They are very strenuous and demand more than 24h to fully recover
- **LO activities** cause slight Metabolic Fatigue, but the recovery is pretty fast after the training session. They are also used as active recovery
- On the following page is the modified table by **Kelly Bagget** classifying training activities into HI and LO groups

High Intensity activities

1. Strength work (anything above 80% of 1RM for lower body and "whole body" movements such as deadlifts, squats etc.)
2. Lower body hypertrophy work (8-12 reps to failure)
3. Maximum effort speed work with full recovery between reps
4. Maximum effort plyometric work (e.g. depth jumps)
5. Maximum effort agility and deceleration work with full recovery between reps
6. Maximum effort conditioning work (ie. Timed max effort intervals)
7. Any activity performed with heightened and competitive emotional intensity (competitions)
8. Any activity performed under the influence of artificial stimulants (ephedrine, various energizing supplements)
9. Technique work (shooting, tackling, finishing drills, duels, shoulder charge, shielding the ball, long pass)
10. Tactics (high intensity tactical drills, duel games)

Low intensity activities

1. Aerobic work
2. Sub-maximal conditioning work
3. Dynamic warm-ups and form running drills
4. Upper body isolation bodybuilding work (curls, triceps)
5. Sub-maximal speed work with full recoveries (runs less than 80% top speed)
6. Easy plyometric work (basic unilateral and bilateral hops etc.)
7. Footwork drills (agility ladders and dot drills)
8. Jump rope
9. Low intensity technique work (passing, receiving, heading, dribbling)
10. Tactical training (analytical, low intensity)

- Every training component in mine system has classification of the means used to general, specific and competition, along with classification of fatigue they cause to HI, ME and LO

Training Components	Fatigue Type	Means that are used
Technical Work Component	LO, ME, HI	General, Specific, Competition
Tactical Work Component	LO, ME, HI	General, Specific, Competition
Speed Training Component	HI	General, Specific
Strength Training Component	HI (ME/LO)	General, (Specific - Sled work?)
Plyometric Training Component	HI (LO)	General
Work Capacity Component	LO	General, Specific, Competition
Metabolic Conditioning Component	HI, ME	General, Specific, Competiton

- During one training microcycle (usually a week), days of HI and ME activities are alternated with LO days
- With this approach all HI activities are grouped in one day, which allows better recovery, prevents training monotony and overtraining
- This is not needed for beginners and kids, cause they cannot tax their system too much to cause too much fatigue (see **Charlie Francis Training System**)

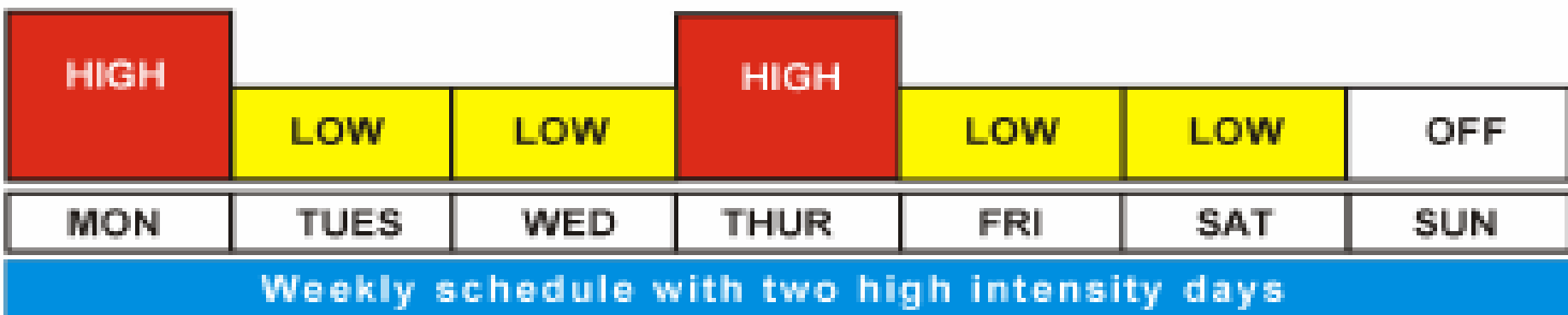
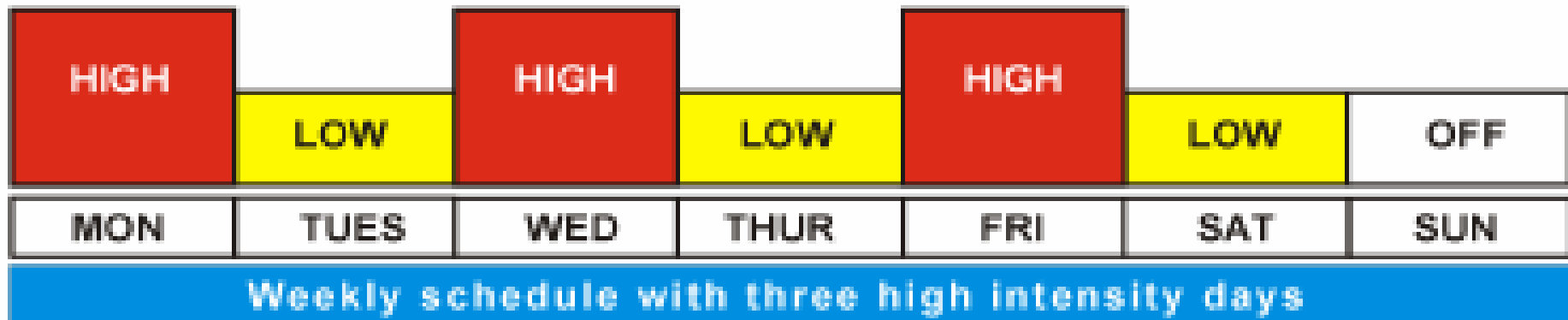

* Taken from Charlie Francis Vancouver Seminar slides

- How to organize the training?

- One solution is to 'mechanically' split the year into periods with different emphasis – for example – we have a preparatory period of 8 wks; wks1-2 are blocks of emphasised Work Capacity and Strength; wks3-6 are blocks of emphasis on Speed, Plyos and Technique while wks7-8 are blocks of emphasised Tactical work, Metabolic conditioning and 'unload' before a first match.
- Another option to organize the training according to 'biology of adaptation' (**Verkhoshansky** is proponent of this), where training periods (or blocks) are organized according to player's needs, adaptation characteristics etc, without taking into account competition schedule.
- **Al Vermeil** (if I understood correctly) use similar model, where athletes stay in a certain training block until they fulfill minimal norms for a given trait – for example – until athlete cannot squat $1.5 \times BW$ he stays in Strength Block where strength training is emphasised. After this he 'goes' into Strength-Speed block where the norm to fulfill is to power clean $1.1 \times BW$ etc

- Although both methods are used, both have pro's and con's
- **'Mechanistic'** approach don't take into account evaluation of the player, his needs, his recoverability etc. 'Mechanistic' approach is based on the development of sport form at a given time period
- **'Biological'** approach, contrary takes into account players needs, evaluation, recoverability, but don't take into consideration competition calendar and the development of the sport form for a given period
- **The solution** is to take into account (a) **training context** (competition calendar, wheather, facilities, time aviable, etc), (b) **goals** of the training year and periods, (c) **athletes** (needs, strengths&weaknesses, evaluation, adaptability, preparedness, age etc) and also to take into account the laws of sport form development. Planning should be from whole-to-parts, and from end-to-beggining
- Again, the concrete solution depends on the mentioned factors – for example – if the preparatory period is very short (4wks) there should be not so much 'splitting' and 'thinking'; coach should identify 'key factors' for success and deal with them concurrenly and aim to achieve the state of sport form for the competitions

- One hypothetical example of training organization (of preparatory period) is the split into the following blocks
 1. Work Capacity Block
 2. Strength, Speed and Power Block
 3. Metabolic Conditioning Block
- In each Block, all Components are present but key ones are emphasised, while more specific emphasis within each Component is based on player's evaluation and his needs, while the Blocks are put in succession to allow achievement of sport form for the competition period

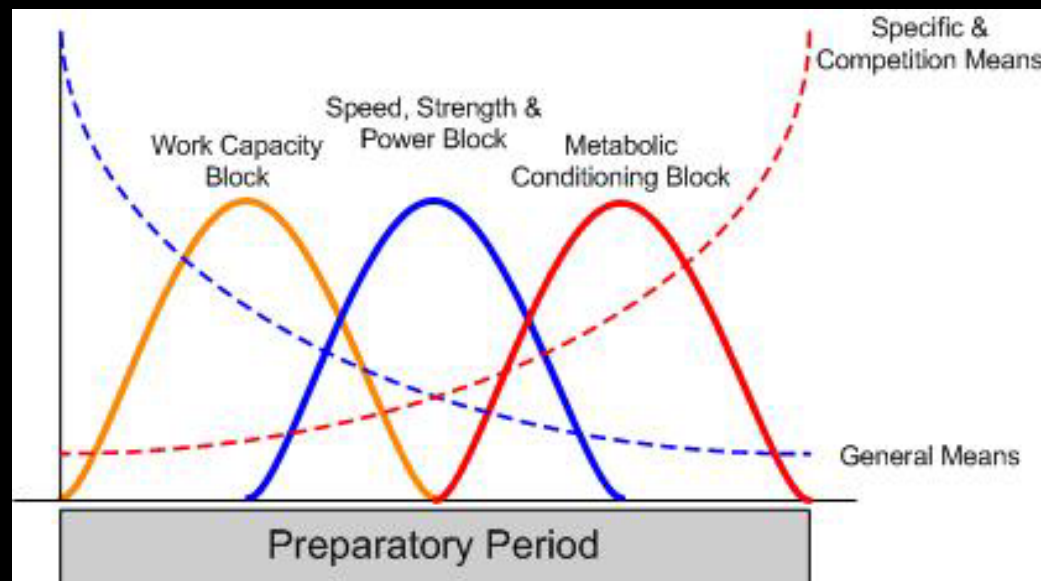

- **In Work Capacity Block**, coach should evaluate players and prescribe training objectives for each – for example – if a player lack ‘aerobic power’ tempo running is prescribed; if the player is injured, have imbalances, then rehabilitation and recovery are prescribed; if the player is very skinny, hypertrophy work is emphasised; if the athlete is fat then nutrition counselling, tempo work, strength complexes and circuits are prescribed; if player lack technique of running, cutting, then technique emphasis is prescribed etc, etc
- **In Speed, Strength and Power Block**, coach evaluate players preparedness and his needs and prescribe training objectives – for example – if the player is weak as a kitten, general strength training is emphasised; if the athlete lacks elasticity plyometrics are emphasised; if he lacks speed but is strong, then speed training is emphasised, etc, etc (see *Power vs. Elastic Athlete*)
- **In Metabolic Conditioning Block**, coach evaluate players preparedness to play and prescribe training objectives – for example – if the player lacks aerobic power, then more tempo work or small sided games are prescribed; if the player lacks RSA and/or SE, then duel games, repeated sprint are prescribed, etc, etc

- This way, both players needs and the development of sport form are adressed
- Again, this is just hypothetical model – in real life, thing are a lot more complex than this!
- Now, lets deal with individual components of the training system...

Technical Work Component

- It can take years to learn how to master certain technical moves and skills, but learning how to operate tactically within a system can take just a few weeks. (*FIFA Manual*)
- The **goal** of Technical Work is mastering of technical elements (skills), but not in 'isolated' manner, but rather in context, both internal (fatigue, arousal, emotional states...) and external (opponents, chasing, stress...)
- It must be remembered that soccer is an 'open' activity, where players must 'react' to external stimuli, so rehearsal of technical moves must be also open in nature
- Any soccer related drill can be 'technical' as long the emphasis is on rehearsing and practicing technique – some forms may be:
 1. Analytical Work
 2. Work in pairs, triangles, squares
 3. Poligons
 4. Small Sided Games
 5. Etc, etc
- Means can be also general, specific and competition, and loads can be HI, ME an LO in nature

- It is also impossible to separate 'technical' work from conditioning work – there is always some overlapping. Technical work cause metabolic response too, while metabolic work can have technical demand and mostly under the state of fatigue, stress etc.
- For mentioned reasons, planning of technical work should be put into bigger context (Training System), cause there are always overlappings between components, especially because technical work may cause all types of fatigue. Everything depends on smart planning and good instruction to the players
- 'Low-Intensity training should, according to our view, not gain priority in the planning of aerobic capacity of soccer players as they will naturally perform such efforts during technical and tactical drills in normal soccer training' (Stølen et al., 2005)
- For this reason technical work usually represent 'low intensity aerobic work', so it is not necessary to repeat that kind of training nor in Work Capacity Component nor in Metabolic Conditioning Component
- Some 'technical demanding' activities will be covered in other components, cause it is impossible to split Components without overlapping

- It is important to say that technical training should be organized using contextual learning, random practice and variable practice (see: Motor Learning and Performance by Richard Schmidt, 2004)
- Since technical knowledge of the players and fast performance of moves are very important, technical training should be present year-round in training sessions, while its emphasis varies with the experience and the age of the player and period of training.

Tactical Work Component

- The goals of tactical training are the follows
 1. Learning of individual, group and team tactical elements and principles
 2. Learning to play under team play style (and preparing for a match)
 3. Learning 'game intelligence'
- The forms of tactical training can be numerous and they are way out of mine 'expertise'
- It is also important to notice that there are also overlappings between tactical training and other training components
- It is also imposible to avoid metabolic response of the tactical training
- All types of means can be used and all types of fatigue can happen with tactical training - this is why smart planning is a must and avoidance of overlappings (why to repeat something that is achived with tactical/technical training with metabolic conditioning and work capacity work?)
- Altought some forms of tactical drills will be mentioned in both Work Capacity and Metabolic Conditioning, it should be mentioned here that design of technical-tactical drills **with conditioning objectives** should take into account **playing style** of the team, or in other words, to implement that kind of tactical tasks which are specific for team's style of play, and/or position played of the player

- Goals in both Technical and Tactical Work Components depends on athlete's age and experience, along with year period
- Numerous books are written about soccer technique and tactics, so neither I do have knowledge, nor it is possible to adress all those technical/tactical issues in this presentation
- Anyway, the important thing is that planning of both technical and tactical work should be put into bigger picture with other components
- For this reason, head coach and conditioning coach must have good communication and clearly defined goals, objectives and methods
- **Play in order to learn; don't learn in order to play!**

Speed Training Component

- Soccer is NOT sprinting, although linear speed is very important component of soccer preparedness
- When talking to 'speed' in soccer, most coaches think of **AGILITY**
- Unfortunately, the term **AGILITY** is hard to define, although **Sheppard & Young (2006)** gave the following definition: “**a rapid whole-body movement with change of velocity or direction in response to a stimulus**”
- 'in response to a stimulus' is a key part of the definition, meaning that athlete, along with having a 'rapid whole-body movement' should have also ability to read the game situation, anticipate and have quick decision making
- For this reason, **Sheppard and Young (2006)** outlined that there are two main components of agility – **change of direction speed** and **perceptual and decision-making factors**. Within these two main components, sub-components exist, as outlined in the picture on the following page

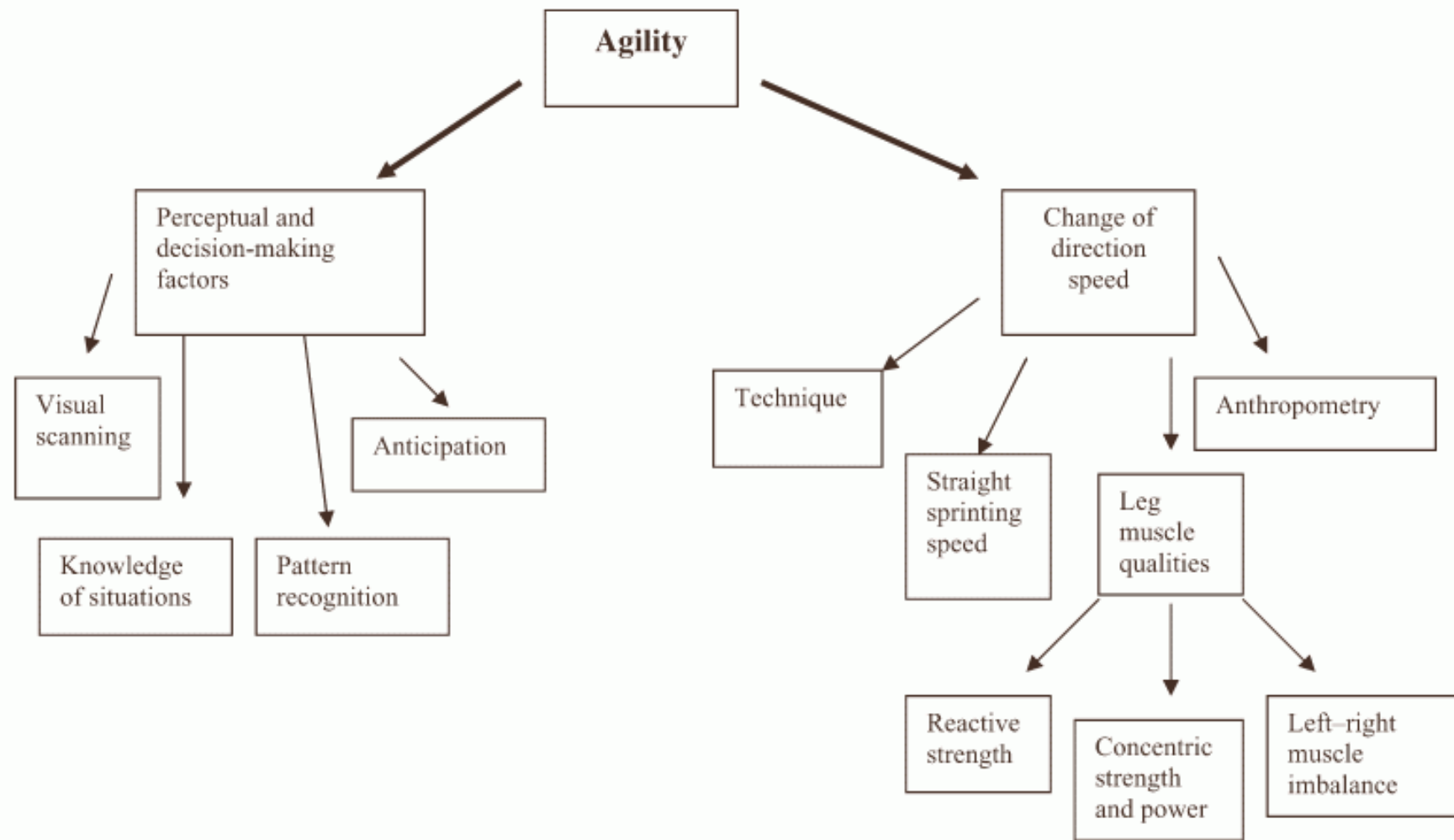

* Taken from Young et al. (2002)

- The point is that athlete can be fastest on 30m, but pretty much 'slow' in the game due poor 'perceptual and decision making factors'
- To be fast in a game, you must have 'game intelligence' first, and then 'pure speed'
- Agility is then **NOT** a bunch of cutting drills like Illinois, T-drill, L-drill, 8s, Zig-Zag runs etc, because the change of direction is PRE-PLANNED, and it is also shown that during the pre-planned change of direction athlete uses movements that are not happening in a REAL agility task (read: game)
- During the pre-planned change of direction, athlete have time to re-adjust his posture which results in movements and forces that are not specific for a change of direction in a game (in response to a stimuli – open situation)
- Thus, performing a bunch of agility drills **DO NOT** prepare athletes to change direction in time-limited situation in response to a stimuli and may predispose athlete to injury due poor motor patterns learned in closed situation (pre-planned) and great stress to ankle, knee and hip when performing them.
- **Thus the best training to develop agility is...** drums please... **playing soccer!!!!** Add in some tag games, mirror drills and you have it!

- What is the relation with agility and linear speed?
- Well, the research showed low correlation between agility tasks and linear speed... but guess what... those researches used 'pre-planned' agility test (or should I say, change of direction tests) like zig-zag runs and compared it to 30m sprint! *Duhhh!*
- I never saw the athlete who cuts left and right in pre-planned manner, although I have seen numerous times that athletes hit sprints for 20-30m in straight line!
- Also, sprinting in a straight line can be seen, not as linear speed training, but rather as **special strength training** (especially hills and sleds) and **the best plyometric activity** for playing soccer!
- Also, the development of **speed reserve** (40-60m) may improve soccer player's endurance (RSA and SE) and decrease the possibility of injury, because players perform at lower %-age of their maximum speed during a game!

- **But do we need this?**
- There is a recent over-flow of agility ladder drills training and SAQ training (Speed-Agility-Quickness), as a means to improve agility - but are they needed?
- They can supplement, but they cannot replace 'the real deal' – sprinting, heavy lifting, jumping and playing soccer
- They are also good for the athletes that falter on their own legs, to improve coordination and technique
- I use 'agility ladder' (or better *coordination ladder*) as a low-level plyometric activity to address 'ankle stiffness' and 'quick feet' (fast repositioning of the feet under the body); they are also usable in warm-up
- One is sure – they will not make you any faster! The ability to apply great force into the ground and in shortest time possible will make you faster, but agility drills, small hurdles won't achieve this!
- Anyway, ladders and some SAQ drills may be used for technique lacking athletes



- Since playing soccer is the best method for developing agility, athletes should spend time developing those **factors that limit agility** performance – relative strength, eccentric strength, core stability, elastic strength, single leg strength, explosive strength, linear speed and acceleration and technique of movement – and not trying to mimick soccer game by doing a bunch of change of direction drills!
- **Deal with the source of the problem, not the problem itself!**
- As I have pointed out, agility can be broken into three types of movement patterns – initialization movements, transitional movements and actualization movements
- Addressing of **initialization movements** is covered by doing linear sprints from various positions and doing low-level plyometrics (quick-feet; see Plyometric Training Component)
- **Transitional movements** are covered by doing technique work which is usually low-intensity in nature
- **Actualization movements** are addressed by doing speed training and soccer technique work

- To cut the long story short, I differ between:
 1. Speed-Technical work
 2. Speed-Power work
- The goal of **Speed-Technical work** is to teach players running mechanics, technique, relaxation, warm-up, principles and balance...
- it is suitable for low-level athletes, technique-lacking athletes, kids, rehabilitation athletes, at the beginning of the training cycle, etc
- Speed-Technical work cause LO fatigue

Speed-Technical Work	
Linear	Lateral
Wall Drills Butt-kicks A-skip B-skip Skips Build-Ups (emphasis on relaxation) Skip over small hurdles (emphasis on knee lift) ...	Agility ladder drills (Icky shuffle) Shuffling Cross-overs Deceleration techniques (forward, backward...) Lateral Skips (over small hurdles...) *Going from simple closed situation, to open ...

- The goal of Speed-Power work is to increase the 'engine' – to build more power to the ground.
- It can be classified to **general** and **specific**

General Speed-Power	
Linear	Lateral
Short Hills Sled work Sprint from various positions Ins&Outs	Cross-overs with sleds Cross-overs on 5m back and forth Sprints from jumping forward, lateral, from zig-zag bounding etc Mirror Drills <i>* Lateral stuff is adressed by doing lateral plyos</i>

- Sprint distance can increase from 10m up to 40m or even 60m over time
- The rest between the reps is about 1min per 10m and 3-5mins between sets
- Total volume should not exceed 300m per day
- Soccer athletes are team athletes, they love competition – they are not track&field athletes who do what they are said to do.
- Soccer players always screw something up, this is why even a speed training should have a 'competitive spirit' or even a ball involvement
- Chase, relays etc., are great way to motivate them to give 100%
- The coach must think of drills that motivate them and create 'competitive environment' while aiming at speed development

Chase...

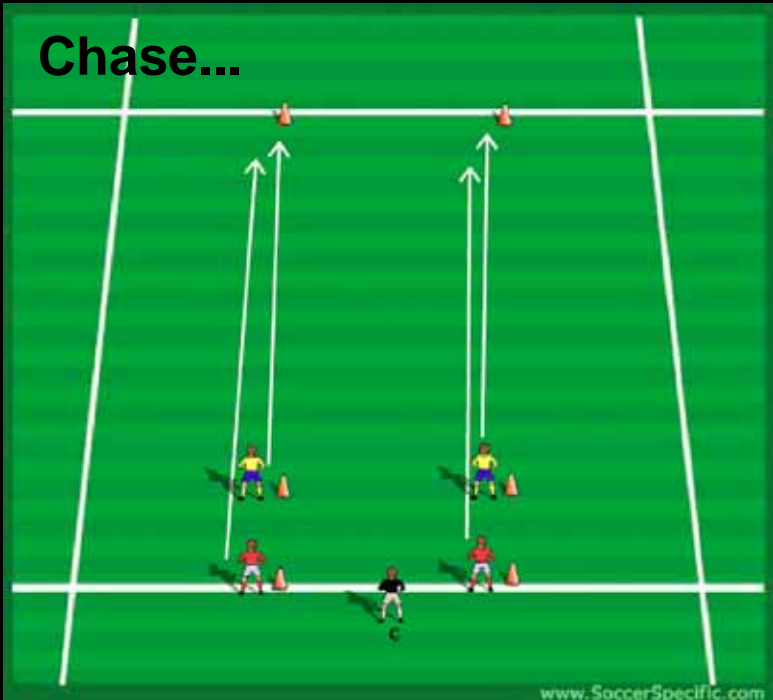

Switching sides...

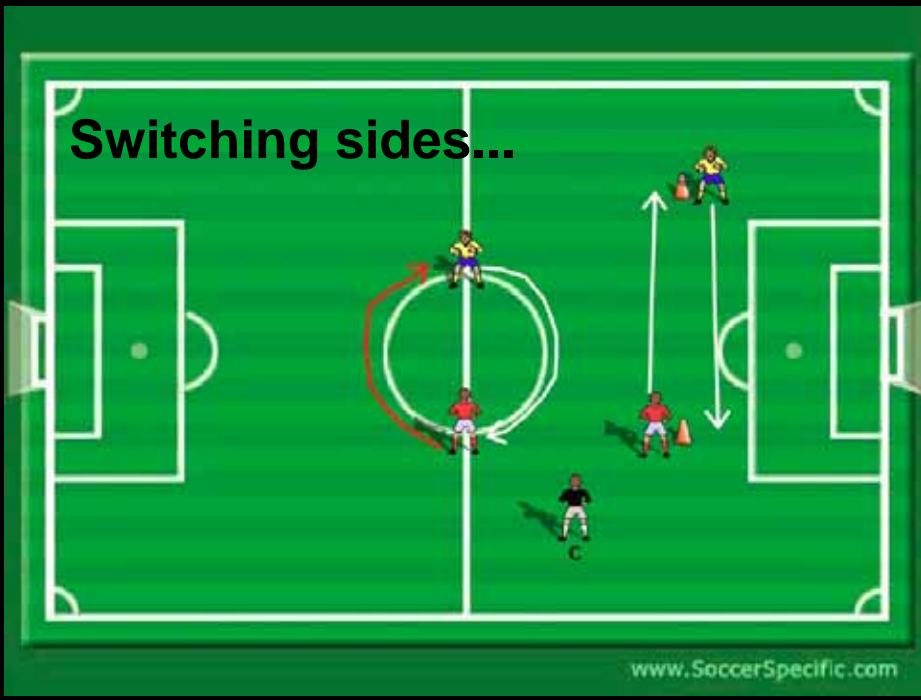

Relays...



- The goal of **specific Speed-Power Work** is to work on speed in soccer specific situation and also practicing soccer related techniques with speed emphasis
- Speed training with the ball...
- Usually this also represent technique work under pressure, like dribbling a ball away from chaser...
- They can be position-specific in nature and together with head coach the drills are designed with team style of play and positional requirements (and common situations) on mind

Specific Speed-Power Work

Chasings the opponent with the ball
Practicing hip turn on the ball
Shoulder tackle at speed with shoot on the goal
Sprint into space for the ball with shoot on the goal
Various finishing drills with passive-active opponents
Various TAG games

...

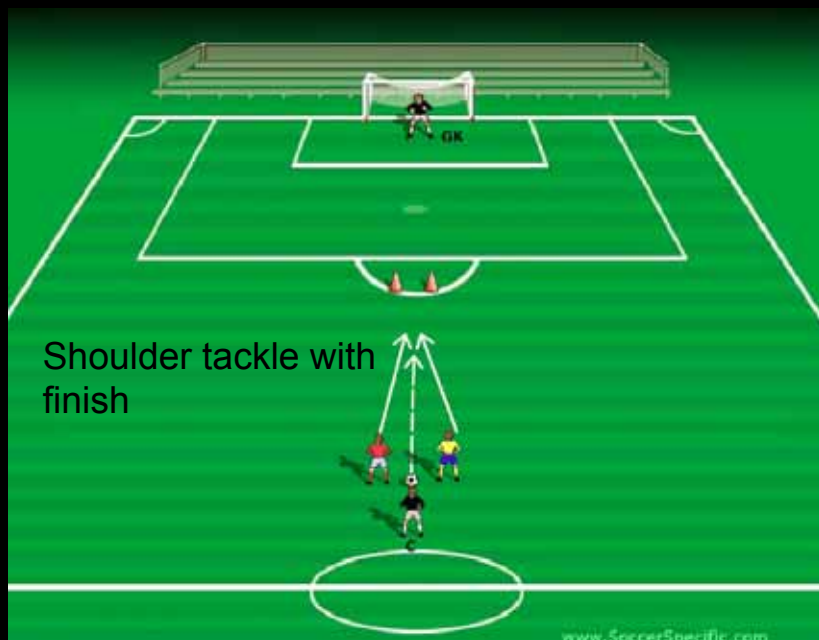
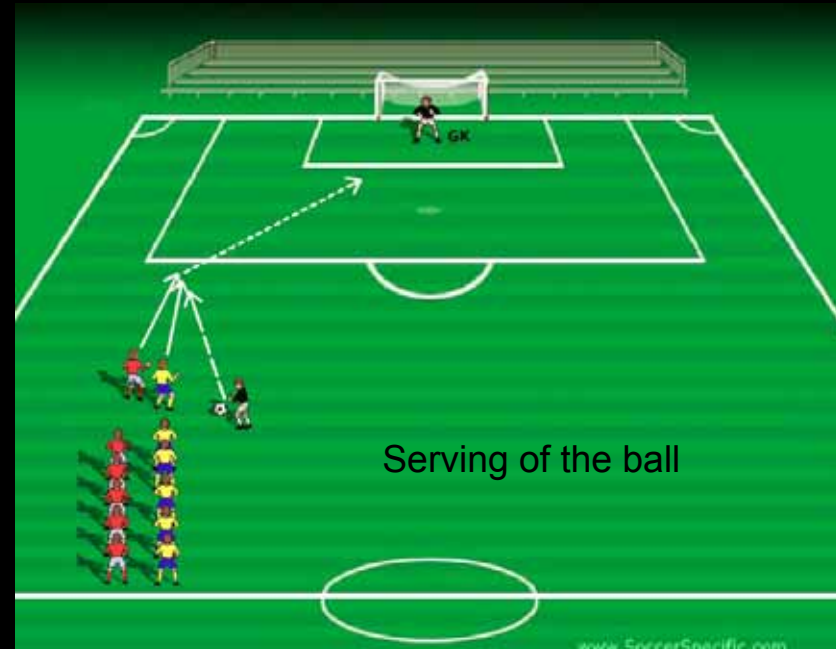
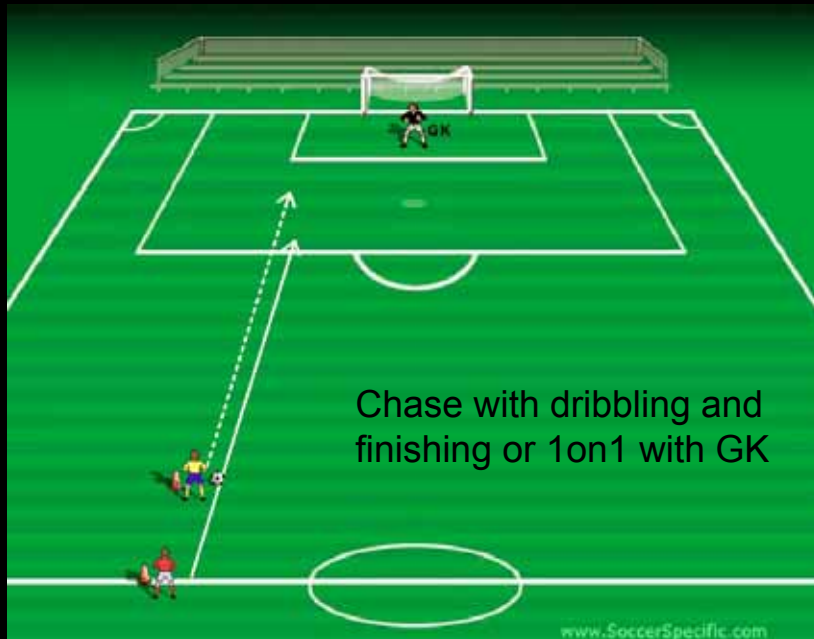

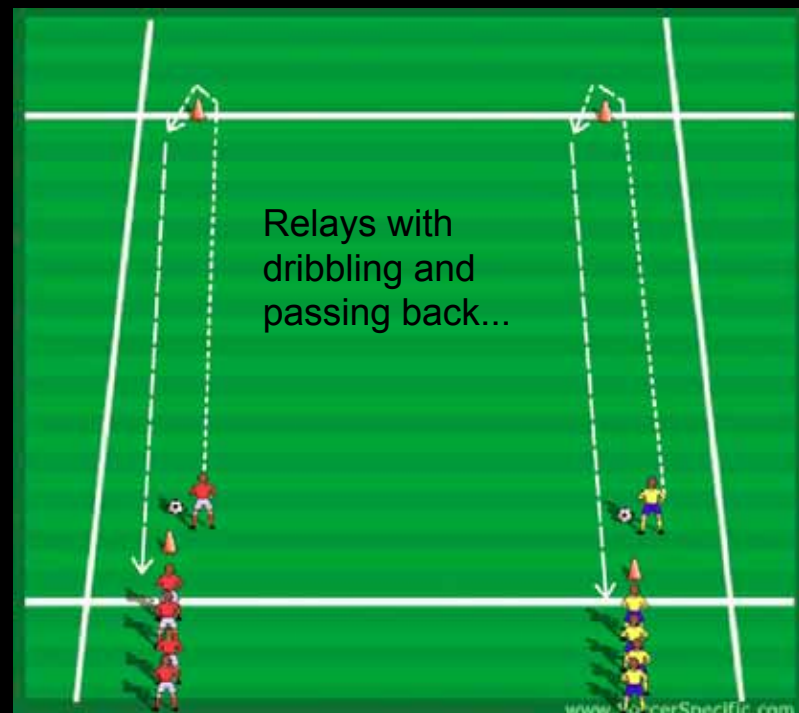
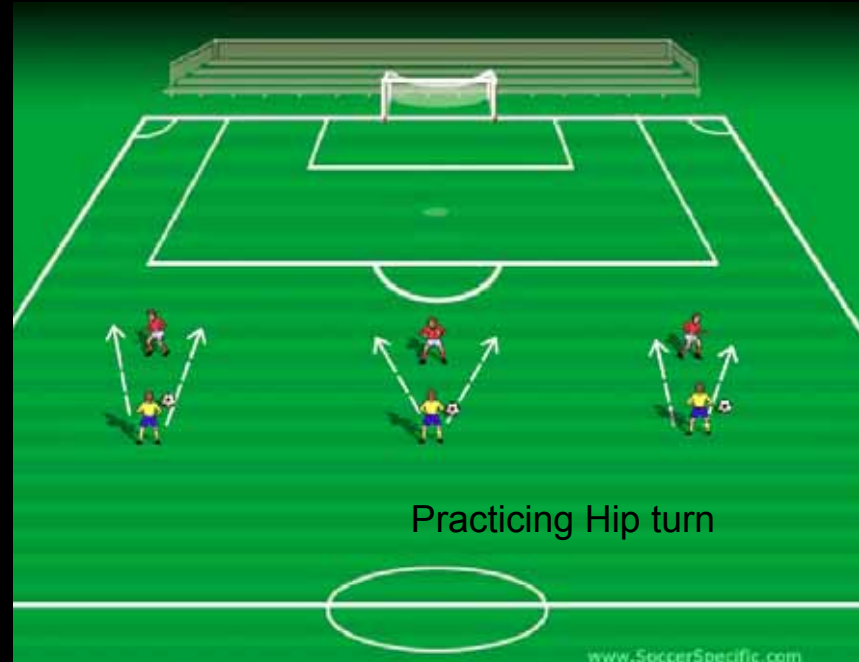

1. Speed exercise with conclusion

Organisation:

- 14 to 16 players per exercise.
- Half pitch and one goal with goalkeepers.
- Distance of the action 20 - 30m.
- 6 to 8 repetitions. After each action, the players return at a slow running pace. Full rest. 2 to 3 sets.

Procedure:

- The blue player A sets off, running (10m) as far as the 2nd cone, controlling the ball as he runs and taking it as far as the penalty area, where he attempts to score or pass sideways for his team mate B, who has set off at the same time (emphasis on timing).
- The yellow player sets off at the same time as the blue player A, controls the ball and attempts to prevent a goal being scored. Players and sides are then switched.

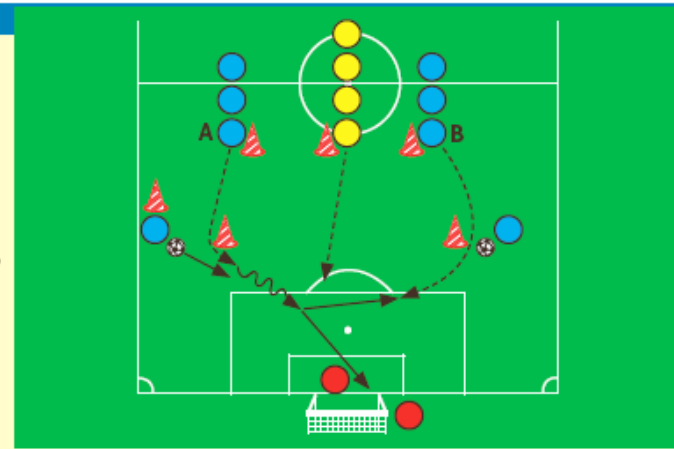

2. Speed exercise combined with a game situation

- Organisation:** - 14 to 16 players per exercise. - Half pitch; one large goal with two goalkeepers. Distance of the action 30m (40m) from the goals. - 4 to 6 repetitions. After the action, the players run slowly back. Full rest. 2 to 3 sets.

- Procedure:** - The blue player A passes to the blue player B at the edge of the 16m area (passing along the ground), who then lays the ball back for A to run onto and cross for C. - The yellow player, who has set off after the one-two by attacker B, harries player A, who has the ball, in an attempt to prevent him from crossing (tackling is not allowed). - The coach then switches the action to the other side and the 2 attackers are changed.

→ Depending on the distance covered in the action (i.e. if it is longer), this exercise can also include a speed-endurance training element.

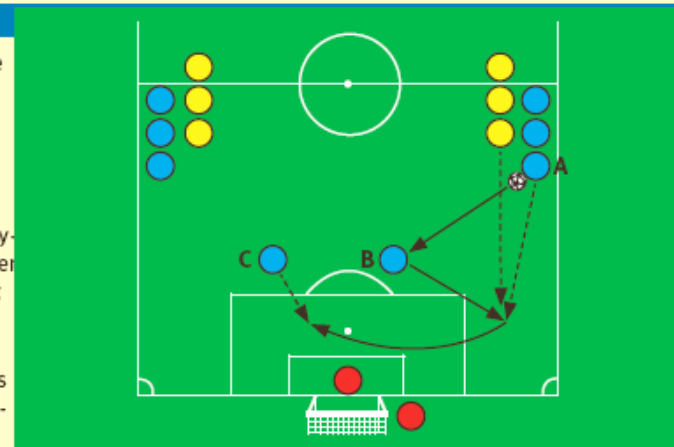

3. Speed exercise with shots on goal

Organisation:

- 10 to 14 players per exercise.
- Marked out area: two goals and two goalkeepers.
- Shooting distance 15m to 20m.
- Repetitions: 4 to 6. After the action, the player walks round and changes sides. Complete rest. 2 to 3 sets.
- Emphasis is on achieving accurate shooting.

Procedure:

- The first two A players pass sideways and then sprint to shoot in the opposite goal.
- The shots and the trajectory of the passes must be varied.
- This can also be staged as a competition: how many goals are scored by each team? → The exercise is also possible without goalkeepers, the players have to aim for accuracy in their shooting with goals marked out by poles.

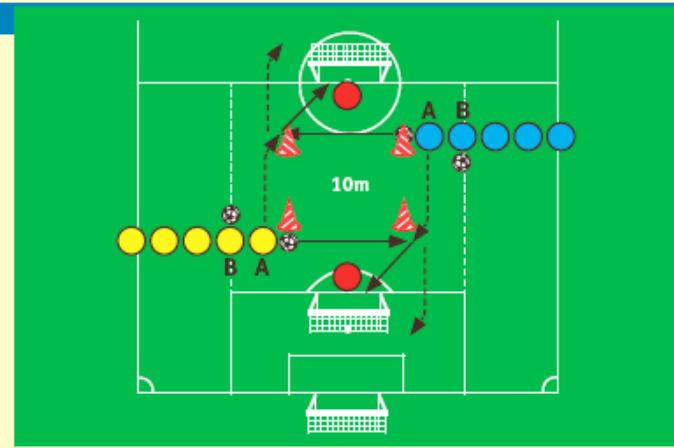

- **To summarize...**
- Agility is complex ability consisting of change of direction speed and perceptual and decision-making factors
- **Playing soccer is the best method to develop agility**
- Although factors that limit agility should be addressed via speed training component, plyometric training component and strength training component
- Speed Training Components is split into (a) Speed-Technique Work and (b) Speed Power Work
- Speed-Technique work consists of all those drills that build coordination and technique of running and change of direction; it is LO intensity in nature
- Speed-Power work is about building power into the ground. It is HI intensity, and it can be further split into General and Specific drills

Plyometric Training Component

- The goal of Plyometric Training Component is development of eccentric strength, elastic strength and explosive strength
- Plyometric Training can be further split into:
 1. Plyos for upper body
 2. Plyos for core
 3. Plyos for lower body
- **Plyometrics for upper body** are not so much important for soccer players (but are for goal keepers) and they will not be explained here in further detail
- **Plyometrics for core** are medball throws against the wall, floor or with partner. They are also a form of upper body plyometrics and they will be discussed in Work Capacity Component
- **Plyometrics for the lower body** are various forms of jumps, hops and bounds. The classification of lower body plyos is found on the following pages

- **Low level plyometrics** are aimed at introducing athletes to plyometric training, improving ankle stiffness (energy transfer), quick feet repositioning (aimed at improving initialization movement patterns)...
- They cause LO intensity fatigue and may be used pretty often
- The progressions can be done by going from DL to SL, using 5-10kg plates or medballs in hands, etc, etc

Low level plyometrics

Line drills (forward/backward, left/right, staggered)

SL line drills

Pogos

Low squat jumps

Zig-Zag DL and SL hops

Dot drills and start drills

Hip wide-outs

Quick hip drills (Hip turn drills)

Low box drills

Agility ladder drills

Jump Rope

- **Deceleration plyometrics** are aimed at improving deceleration abilities of the athletes, eccentric strength, injury prevention, teaching soft landing and energy absorption...
- They usually cause HI intensity fatigue but this depends on the height of the jumps and their intensity
- Progression can be implemented by using DL, SL, 90 and 180deg rotations, holding 5-10kg plate or medballs etc...

Deceleration Plyometrics

Squat jump and stick
Lateral Jump and stick
Broad jump and stick
Crow hop
Lunge jump and stick
Jump and stick over hurdles
SL jump and stick over small hurdles
Jump, rotate and stick
Zig-Zag bounds and stick
Agility ladder with deceleration and stopping emphasis
Depth jump
Depth jump into lunge
Push into lunge
Push into side lunge...

- **Acceleration transfer plyometrics ('UP' variations)** are aimed at increasing concentric explosive strength, from deep knee and hip angles and thus have the greatest transfer to the acceleration phase (first couple of meters of sprint); long GCT, great knee and hip bend; voluntary force
- They cause HI intensity fatigue
- They are classified into lateral and linear subtypes

Acceleration transfer plyometrics ('UP' variations)	
Linear	Lateral
Explosive medball throws Squat jumps (with pause and rhythmical) Stair jumps Squat jumps with plate 5-20kg Lunge jumps (rhythmical) Step-Up jump (pause, rhythmical, change of foot, medball throw) Standing long jump SLJ in series Standing tripple jump Squat and press (plate, diagonal) ...	Zig-Zag bounds with great knee bend Side-to-side jumps (on flat, or with inclined surfaces) Lateral Squat Jump Lateral Squat jump over hurdles Side-lunge fall and explosive push-off ...

- **Max Speed transfer plyometrics ('FLAT' variations)** are aimed at improving elastic abilities of the player; shorter GCT, less knee and hip bend, less voluntary force
- They cause HI intensity fatigue
- They are classified into lateral and linear subtypes, with medium, high-intensity and short-response subtypes

Max speed transfer plyometrics ('FLAT' variations)	
Linear	Lateral
<p><i>Medium intensity</i></p> <ul style="list-style-type: none"> Jumps in place (tuck jumps) Hurdle jumps (squat, RDL position) Pogos Tripple jump with pre-run Box-to-box jumps Jump from a pre-run Rim jumps <p><i>High intensity</i></p> <ul style="list-style-type: none"> Depth jumps <p><i>Short-response</i></p> <ul style="list-style-type: none"> Power Skipping Bounding SL hops 	<p><i>Medium intensity</i></p> <ul style="list-style-type: none"> Lateral Cone jumps Lateral Hurdle jumps Lateral box-to-box jumps Zig-zag bounds <p><i>High intensity</i></p> <ul style="list-style-type: none"> Lateral Depth jumps <p><i>Short-response</i></p> <ul style="list-style-type: none"> SL Zig-zag hops SL lateral hops

- **Planning of plyometric training** should be based on athlete's evaluation and his needs: more 'powerfull' athletes will need more 'FLAT' variations of plyos, while more 'elastic' athletes will need more 'UP' variation of plyos
- **Michael Boyle**, uses the following periods which lasts 3-4 weeks each:
 1. Single Response, Stabilization (linear, lateral)
 2. Multiple Responses, Stabilization (linear, lateral)
 3. Multiple Jumps, Introduction of Elastic Component (linear, lateral)
 4. Muliple Jumps, Elastic Response (linear, lateral)
- Basically Boyle goes from deceleration plyos toward 'FLAT' plyos over time
- **Christian Thibaudeau** reccomend using block organization of plyometrics where high-intensity plyos (depth jumps and drop jumps) are inter-spread with low intensity plyos, because if done continuously, depth jumps lose their performance increasing capability

Block 1 (4 weeks)

Altitude landings

Block 2 (4 weeks)

Low intensity jump training

Block 3 (4 weeks)

Depth jumps

Block 4 (4 weeks)

Low intensity jump training

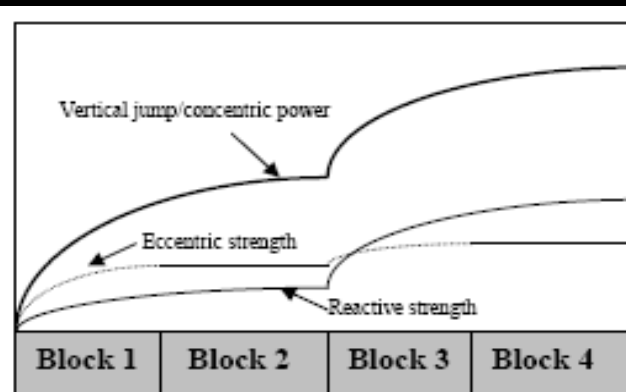

- Well, because **low level plyos** represent 'chicken-soup' work, they can be done year round and maybe put into latest part of the warm-up
- **Deceleration plyometrics** are awesome for beginning phases of training, where one should teach landing mechanics. During this phase (Work Capacity Block) deceleration plyometrics are emphasised more
- Since **depth jump** represent the highest level plyometrics, it should be done only couple of times per year
- Both UP variation and FLAT variation can be done year round with greater volume during Speed&Power Block, where ratio between them depends on athletes evaluation (Power vs. Elastic Athlete)
- Also, UP variation may coincide with work on acceleration, while FLAT variations may coincide with work on max. speed in Speed Training Component
- For example:
 1. **Work Capacity Block:** Deceleration plyos and some 'UP' plyos
 2. **Strength, Speed and Power Block:** Greater volume of plyos, but ratio between 'UP' and 'FLAT' depend on athlete
 3. **Metabolic Conditioning Block:** Low volume of both 'UP' and 'FLAT' plyos
- Low level plyos are done in each block with greater volume in 1st block

Strength Training Component

- The goal of strength training is to: (a) **reduce number of injuries**, (b) **improve on field performance** by increasing strength, strength-speed, explosive strength, (functional) muscle mass...
- **Strength training is a mean to an end, not an end to itself!**
- Reduction of injuries should happen not only in the gym, but more importantly, on the field!
- I am proponent of whole-body training with free weights, using 'general' strength exercises not 'specific' exercises
- Classification of strength training exercises is the following
 1. **Whole body exercises**
 2. **Upper body exercises**
 3. **Lower body exercises**
 4. **Core exercise**

- **Whole body exercises** are Olympic Lifts variations
- Whole body exercises develop strength-speed rather than strength, they also develop **triple-extension** which is very important for speed especially acceleration phase and jumping ability
- They can be further classified into **Pulling**, **Pushing** and **Combination movements**

Pulling Movements	Pushing Movements	Combination Movements
Full Pull & Catch Hang Clean Hang Snatch <i>Triple extension</i> Clean Grip Shrug Pull Snatch Grip Power Pull	Presses Push Press DB Push Press <i>Jerks</i> Split Jerk Power Jerk	Hang Clean to Power Jerk Squat to Push Press Hang Snatch to Overhead Squat DB Clean to Push Press

- **Upper body exercises** can be classified into Pulling, Pushing movements both in Horizontal and Vertical direction, along with some isolational movements

Horizontal Press	Vertical Press	Horizontal Pull	Vertical Pull	Elbow Extension	Elbow Flexion	Shoulder Rotations
Bench Press Incline Bench Press Narrow Bench Press Pull Over Push Ups	Military Press Press Behind the Neck DB Presses Plate Raises	Bent Over Row Seated Row Scare Crows DB Row One Arm One Leg Cable Row Inverted Row	Chin Up Pull Up Lat Pull Down Standing Pull Down Strenum Chin Up	Dips Cable Push Down Various Triceps Extensions	Curl Reverse Curl DB Curls	Shrugh Reverse Raise Front/Lateral Raise Rotator Cuff

- **Lower body exercises** can be classified into Knee Dominant and Hip Dominant movements, both done with Single Leg or Double Leg
- Hip Dominant Movements done with bent legs (bridges) are considered in Core exercises

Knee Dominant Movements			Hip Dominant Movements	
Double Leg	Single Leg		Double Leg	Single Leg
Full Back Squat Parallel Squat Front Squat DL Zercher squat Over Head Squat Natural GHR Double Leg Curl	<u>Leg Push</u> SL squat Bulgarian Squat Split Squat Over Head Split Squat Single Leg Curl <u>Horizontal</u> Standard Lunge Walking Lunge Reverse Lunge	<u>Lateral</u> Lateral Lunge Shuffle Lunge Lateral Split Squat <u>Vertical</u> High Step Up Low Step Up <u>Lateral Vertical</u> Lateral Step Up Cross Over Step Up	RDL Sumo RDL Sumo Hyper Exts Reverse Hyper Leg Raises (hip flexors)	Single Leg RDL Single Leg Hyper Exts Single Leg Reverse Hyper Single Leg Raises (hip flexors)

- **Core exercises** are aimed at abdominal muscles, low back muscles, scapulae and humerus stabilizers, hip abductors, hip external rotators, glutes, hip flexors...
- Core exercises are considered 'neuromuscular-education training' and activation training rather than strength training
- Hundreds of curls are NOT done in mine system, because abs are very taxed by heavy lifting, sprinting and jumping, and rather serve to prevent spine motion than to create it! (see: *Shirley Sahrmann; Stuart McGill works*) – anti-rotators and anti-flexors!
- Core is also 'worked' with medballs in Work Capacity Component
- Some 'strength training' for core may be done and may include shoulder to hip flexion, hip to shoulder flexion, plate raises, sit-ups with heading or medball toss, hanging leg raises etc, etc

Some core exercises...

McGill Big Three

Eccentric Leg lowering

Stabilizing core while doing various leg actions

Bridging (Cooks, double leg, single leg, marching...)

Abduction

External Rotation of the hip

Anti-rotary training: kneeling and standing chops

Psoas activation work

Shoulder pre-hab (YTWX, external rotation...)

- According to their goals, exercises can be also classified to **Core/Foundation Exercises**, **Supplemental Exercises**, **Major Assistance Exercises** and **Secondary Assistance Exercises**
- **Core/Foundation Exercises** are multi-joint barbell exercises. Everything else revolves around those „main players“. Preferably, one exercise per movement category should be Core/Foundation exercise. This exercises will give the best indication of overall strength. Exercises like squats, power cleans, bench and military press, pull-up are considered Core/Foundation Exercises
- **Supplemental Exercises** are special exercises used by Westside Barbell Club, used to add variety and complement the corresponding Core/Foundation Exercises. Supplemental exercises are done to improve Core/Foundation Exercises with elite athletes, or with athletes who reached very high level in strength and who need more stimuli and complexity to progress. These exercises are primarily multi-joint barbell exercises, which train similar muscle actions as the Core/Foundation exercises in slightly different movement planes and angles

- **Major Assistance Exercises** assist in development of the muscle or muscle groups that are used in the execution of Core and Supplemental exercises, also they work stabilizers and antagonistic muscle groups of the prime mover exercises, they help avoid muscular imbalances that can lead to injury, help in development of mobility and flexibility, balance, coordination and proprioception
- **Secondary Assistance Exercises** are single joint exercise and act as stabilizing exercises for the Core/Foundation and supplemental exercises. They are included for rehab or prehab purposes
- For the easier classification, exercises can be also classified into **CORE** and **ASISTANCE** exercises and they have their specific objectives, tasks and thus loading parameters
- Depending on the athlete, goals and context, different exercises are considered CORE or ASISTANCE and also loading parameters and their rotations are planned accordingly
- CORE exercises are usually not rotated that often, while ASISTANCE ones are – to provide variety, prevent boredom, imbalances...

- Strength training should be programmed according to the level of the athlete and his goals
- Athletes are classified according to their **recovery ability** and thus the ability to hit PRs
- According to work of **Mark Rippetoe** and **Lon Kilgore**, athletes are classified into **novices**, **intemediates** and **advanced**

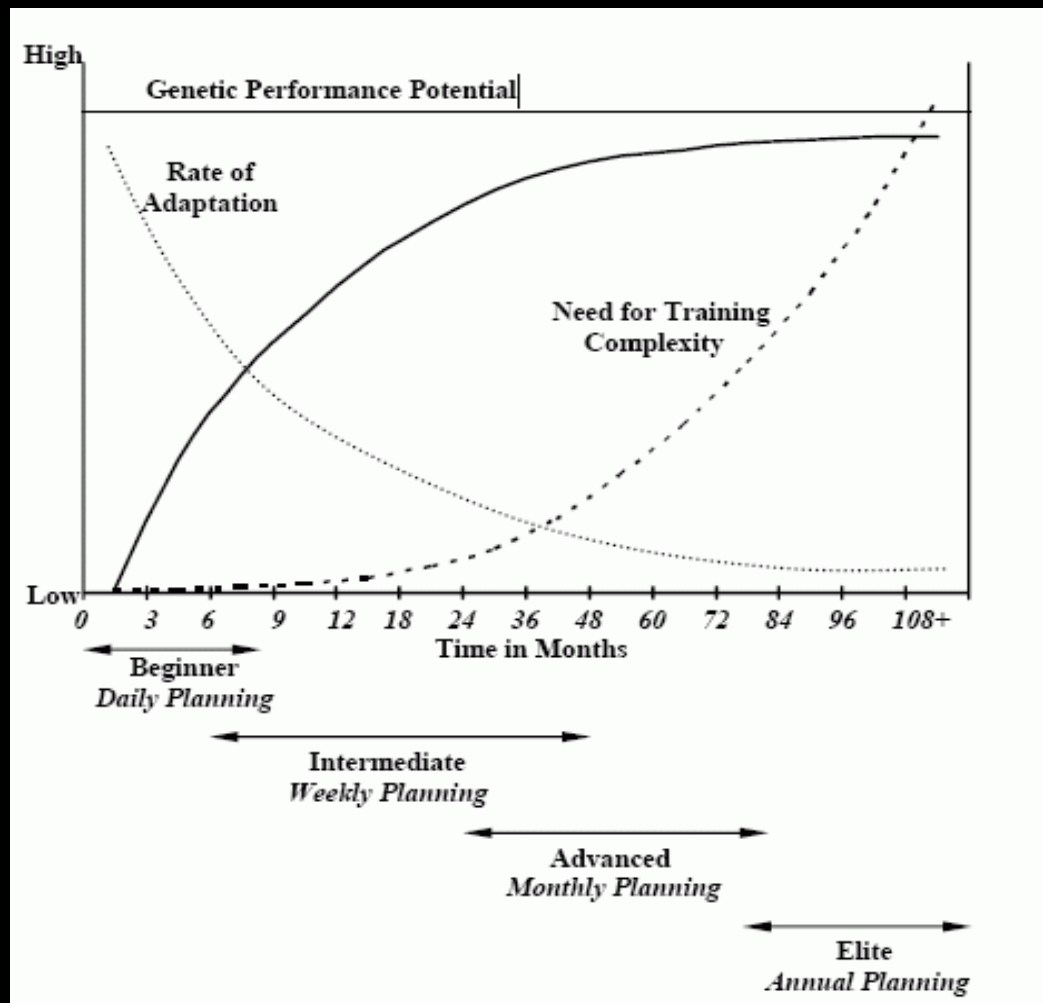

- **Novices** can progress from training session to training session and hit PRs every time they go to the gym.
- The end of novice phase is marked by performance plateau occurring sometime between the third and ninth month of training, with variations due to individual differences.
- The training should be very simple, with small number of compound movements and linear progression in weight used
- Rip and Lon suggest using 5 reps per set, because this allow both increase in strength and mass gain without the disruption of the technique due too much reps per set
- This also allows easier progression in weight (e.g. you can use greater weight jump if you use 5 reps per set, then 10 reps per set)
- **Even if the athlete is advanced in his sport, he is novice in the gym if he lifts for the first time.**
- Novice will not develop overtraining that easily and on the other hand, if they do, the signs will be hard visible (which is 'bad').
- The more advanced the athlete, the longer the off-period and the drastically the reduce in weigh and volume needed.
- If novice start to 'stuck', simple off-day (with reduced weight) is enough to recover them.
- If the unload is used, weight should be reduced for 10% and the cycle should begin once again.
- If the novice show constant need for off-day, then he should progress toward intermediate programming.

- Example of **novice program** may look like this

<u>Session A</u>	<u>Session B</u>
A. Power Clean 3x3	A. Power Snatch 3x2
B1. Front Squat 3x5 B2. Pull-Up 3x10	B1. Bench Press 3x5 B2. RDL 3x10
C1. Military Press 3x10 C2. Bulgarian Split Squat 3x10	C1. Seated Row 3x10 C2. Lunge 3x10

- Training sessions A and B may alternate on Mon/Wed/Fri

- When the simple linear approach in increasing weights and hitting PRs every training start to plateau, then novices are not more novices – they are now considered as **intermediate** athletes
- The characteristic of intermediate athletes is that along with increasing strength, athlete's recovery ability increase too, thus they can handle greater load more easily than novices. But, to create adaptive response, intermediate must 'stress the system' with greater loads, and from this load they can't recover till another training. They need more recovery. They can hit PRs every week instead of every training session as with novices.
- The intermediate athletes, due greater recovery needed to 'supercompensate' need more **within-week variations** in training loads, or more easily, they need planned off-days within a week. Those off-days, or days with lowered load can be achieved by using more easier exercises, using less weight and doing same reps, using same weight and doing less reps, reducing number of sets. Upper/Lower split can be used too.
- When it comes to unloading, intermediate athletes need longer period of unload (mostly one week) and greater reduction in weight (around 10-20%) than novices. Again, unloading periods are 'safety valves' that are used to prevent possible overtraining and supercompensate for overreaching. Usually 3+1 (3 weeks loading, 1 week unloading) can work just fine here.
- Intermediate athletes can utilize more number of exercises too.

- According to **Rip** and **Lon**, **most team athletes never exit from intermediate phase**, due their complex structure of abilities needed for their sport (speed, endurance, technique...) which limit them to progress in strength training as strength athletes.
- The intermediate phase lasts for about two years but this depends on the individual athlete.
- What to remember for the intermediate:
 1. **They progress from week to week (hit PRs) due greater need for recovery**
 2. **They need regular off-days during a week or within-week load fluctuations (wave-like)**
 3. **They need longer unload (mostly a week) with greater reduction in load**
 4. **They can use larger number of exercises and their variations**

- Examples of **intermediate programs**:

Variations in load

<u>Monday</u>	<u>Wednesday</u>	<u>Friday</u>	<u>Monday</u>	<u>Wednesday</u>	<u>Friday</u>
Session A (medium)	Session B (medium)	Session A (easy)	Session B (easy)	Session A (hard)	Session B (hard)
A. Power Clean 5x3 B1. Front Squat 5x5 B2. Pull-Up 3x10 C1. Military Press 3x10 C2. Bulgarian Split Squat 3x10	A. Power Snatch 5x2 B1. Bench Press 5x5 B2. RDL 3x10 C1. Seated Row 3x10 C2. Lunge 3x10	A. Power Clean 3x3 @80% B1. Front Squat 3x5 @80% B2. Pull-Up 2x10 @80% C1. Military Press 2x10 @80% C2. Bulgarian Split Squat 2x10 @80%	A. Power Snatch 3x2 @80% B1. Bench Press 3x5 @80% B2. RDL 2x10 @80% C1. Seated Row 2x10 @80% C2. Lunge 2x10 @80%	A. Power Clean 1x3 B1. Front Squat 1x5 B2. Pull-Up 1x10 C1. Military Press 1x10 C2. Bulgarian Split Squat 1x10	A. Power Snatch 1x2 B1. Bench Press 1x5 B2. RDL 1x10 C1. Seated Row 1x10 C2. Lunge 1x10

Rotation of the exercises (movement emphasis of the day)

<u>Monday</u>	<u>Wednesday</u>	<u>Friday</u>	<u>Monday</u>	<u>Wednesday</u>	<u>Friday</u>
Session A	Session B	Session A	Session B	Session A	Session B
A. Power Clean 5x3 (medium)	A. Power Snatch 3x2 @80% (easy)	A. Power Clean 1x3 (hard)	A. Power Snatch 3x2 (medium)	A. Power Clean 3x3 @80% (easy)	A. Power Snatch 1x2 (hard)
B1. Front Squat 3x5 @80% (easy)	B1. Bench Press 1x5 (hard)	B1. Front Squat 5x5 (medium)	B1. Bench Press 3x5 @80% (easy)	B1. Front Squat 1x5 (hard)	B1. Bench Press 5x5 (medium)
B2. Pull-Up 2x10 @80% (easy)	B2. RDL 1x10 (hard)	B2. Pull-Up 3x10 (medium)	B2. RDL 2x10 @80% (easy)	B2. Pull-Up 1x10 (hard)	B2. RDL 3x10 (medium)
C1. Military Press 1x10 (hard)	C1. Seated Row 3x10 (medium)	C1. Military Press 2x10 @80% (easy)	C1. Seated Row 1x10 (hard)	C1. Military Press 3x10 (medium)	C1. Seated Row 1x10 @80% (easy)
C2. Bulgarian Split Squat 1x10 (hard)	C2. Lunge 3x10 (medium)	C2. Bulgarian Split Squat 2x10 @80% (easy)	C2. Lunge 1x10 (hard)	C2. Bulgarian Split Squat 3x10 (medium)	C2. Lunge 1x10 @80% (easy)

Implementing easier exercises (notice the similarity with Kenn's Tier System?)

<u>Monday</u>	<u>Wednesday</u>	<u>Friday</u>	<u>Monday</u>	<u>Wednesday</u>	<u>Friday</u>
Session A	Session B	Session A	Session B	Session A	Session B
A. Power Clean 5x3 (medium)	A. Power Snatch Technical work (easy)	A. Power Clean 1x3 (hard)	A. Power Snatch 3x2 (medium)	A. Power Clean Technical Work	A. Power Snatch 1x2 (hard)
B1. Zecher Squats/SL squats 3x5 (easy)	B1. Bench Press 1x5 (hard)	B1. Front Squat 5x5 (medium)	B1. Alternating DB Bench Press 3x5 (easy)	B1. Front Squat 1x5 (hard)	B1. Bench Press 5x5 (medium)
B2. Lat-Pull down 2x10 (easy)	B2. RDL 1x10 (hard)	B2. Pull-Up 3x10 (medium)	B2. SL RDL/Cook hip Lift 2x10 (easy)	B2. Pull-Up 1x10 (hard)	B2. RDL 3x10 (medium)
C1. Military Press 1x10 (hard)	C1. Seated Row 3x10 (medium)	C1. DB Vertical Press (easy)	C1. Seated Row 1x10 (hard)	C1. Military Press 3x10 (medium)	C1. DB Rows/Face Pulls 1x10 (easy)
C2. Bulgarian Split Squat 1x10 (hard)	C2. Lunge 3x10 (medium)	C2. Split Squats 2x10 (easy)	C2. Lunge 1x10 (hard)	C2. Bulgarian Split Squat 3x10 (medium)	C2. Lateral Split Squats 1x10 (easy)

Implementing Upper/Lower split

<u>Monday</u>	<u>Wednesday</u>	<u>Friday</u>	<u>Monday</u>	<u>Wednesday</u>	<u>Friday</u>
Lower	Upper	Lower	Upper	Lower	Upper
A. Power Clean 5x3	A. Bench Press 3x5	A. Power Snatch 5x3	A. Military Press 3x5	A. Power Clean 5x3	A. Bench Press 3x5
B. Front Squat 3x5	B. DB Military Press 3x10	B. Lunges 3x10	B. DB Bench Press 3x10	B. Front Squat 3x5	B. DB Military Press 3x10
C. Bulgarians 3x10	C. Pull-Ups 3x10	C. RDLs 3x10	C. Row 3x10	C. Bulgarians 3x10	C. Pull-Ups 3x10

- When it comes to implementing intermediate programming into your system or year-round cycle, whether you classify yourself as 'linear guy' or 'concurrent guy', 'conjugate sequence system guy' or 'functional training guy', just remember one thing: **intermediate can hit PRs every week and they need within-week variations in training load.** How are you going to address this, with Upper-Lower Split, easier exercises, load waves, etc., is not important as long as the goals are achieved

- Most non-strength athletes (read: soccer players) will never reach **advanced** stage and will never need complexity of its programming
- Due proximity to their 'genetical limit/potential' these athletes experience very small jumps in strength level. Their work capacity is huge, but to induce adaptive response they must utilize longer periods of accumulated work. They can hit PRs every month and with very small jumps. As intermediate athletes they need within-week variations in training load, but in addition they need within-month variations. What were off-days for intermediate, off-weeks are same for advanced athletes. This makes programming of training for this athletes most complex of mentioned three groups.
- When it comes to unloading, these athletes need longer periods of unload (2 or more weeks, even a month), and greater reduction in training intensity and volume. Overtraining of this athletes is highly dangerous, and according to my humble opinion they need very careful planning and just-in-case unloads.
- Advanced athletes need less lifts than intermediate. This allows them to 'concentrate' on the basic stuff.
- These athletes need to utilize **cumulative training effects**. Also, they need greater variations in volume and intensity. Block training, Accumulation/Intensification schemes, Two-Up One Down schemes are a must.
- Anyway, the programming of strength training for this athletes is so complex that it must be approached individually without any generalizations.

- Once the athlete level, his goals and training context are defined, coach can pick **periodization method (of strength training)** for achieving those goals and **not vice versa!**
- Don't become a slave of a given periodization method... Don't proclaim your self as 'linear guy', 'concurrent guy', 'undulating guy'! Anything that enables athletes to reach setted goals is appropriate – so, better proclaim your self 'goal reaching guy' and use various periodization methods as tools in your toolbox!
- **Periodization is a tool, a method witch you use to organize the development of the athlete based on goals set and criteria, so that athlete avoid being injured, overtrained and tries to be the best prepared at a given time frame.**
- Some periodization methods of strength training are better suited for particular level of the athlete than the others
- Programming is actually 'progression' at lower levels than the periodization is
- The level of the athletes defines the progressions used at a given periodization method
- Thus you can use 'linear system', 'conjugate/concurrent', 'accumulation/intensification' or whatever system of strength training periodization, as along you adapt your programming to the level of the athlete.

- The words periodization and programming are **NOT** synonyms.
- With advance athletes, periodization and programming (progression) becomes very close, because you must periodize the training to induce progression.
- For lower level athletes, periodization and programming (progression) are two different things.
- Just remember that some forms of periodizations of strength training are too much complex for a given level of the athlete. Do not be complex for the complexity sake, but rather to reach defined goals, not to act smartly.

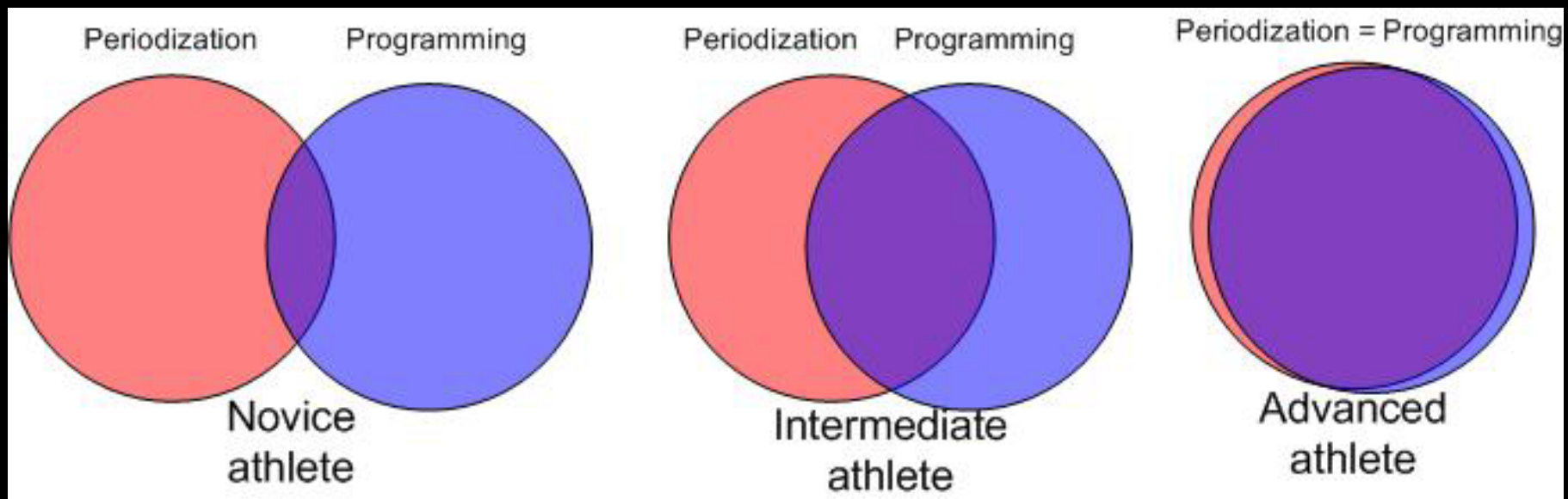

- There are numerous ways to periodize strength training – for more thorough review read this [article](#)
- Also, some other info about periodization methods can be found in this series of [articles](#)
- The thing to remember is that choice of periodization method is based on training goals, athlete's level and training context (competition calendar, duration of preparatory period...) and NOT vice versa
- Some forms of periodization are more appropriate to some levels of the athlete and for achieving particular goals, while some aren't.
- It is also important to see the 'bigger picture' and implement strength training periodization into 'whole' of the training system
- Now lets review some of the most popular periodizaion methods for strengths training...

- **Bompa's scheme (traditional/linear system)**
- This scheme of periodization is very well known. The year-round strength training cycle is split into couple of different blocks with a different goal, namely: anatomy adaptation phase (strength endurance), hypertrophy phase, max strength, power phase or transformation phase and maintenance phase.

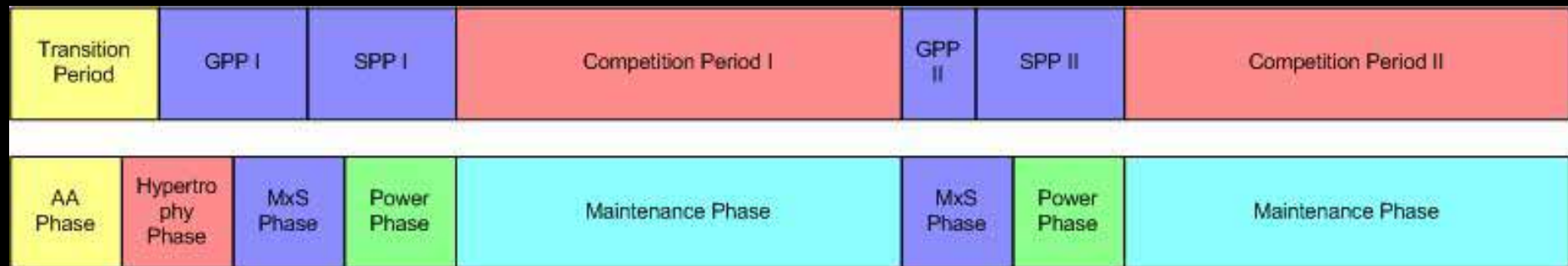

- Can this be used? Yes, off course it can, but is it needed? Well, this question you should answer. But anyway, programming/progressions of the blocks will depend on the level of the athlete. Novices can hit PRs on every training session, while intermediate will need within-week variations to do so. For intermediates, classical scheme 3+1 (3 wks loading and 1 unloading) will work fine. What about advanced athletes? If the blocks are of adequate duration, they can induce cumulative training effects and can work just fine, although some unloading before the Comp Period for 2-3 weeks to supercompensate is a must.

- **Conjugate/concurrent scheme**
- With conjugate/concurrent scheme (in strength training component of training system), we are trying to develop various abilities at the same time (microcycle). Although we could prescribe various rep-schemes for every lift (so called pyramid), the better option is to use Olys for power development along with DE squats/benches, compound movements for max strength and assistance lifts for hypertrophy. Another option is to prescribe different rep-schemes over the week for a given session (undulating).

Transition Period	GPP I	SPP I	Competition Period I	GPP II	SPP II	Competition Period II	
AA work (RE)		Maintenance Phase		AA work (RE)		Maintenance Phase	
Hypertrophy work (SE)				Hypertrophy work (SE)			
MxS work (ME)				MxS work (ME)			
Power work (DE)				Power work (DE)			

- This is the scheme I usually use – we do Olys for power, core lifts for strength and assistance lifts for hypertrophy, balance, mobility etc. Novices can again hit PRs on every training session, while intermediate can hit PRs every week and will need within-week variations. Advanced athletes would need more emphasis on a given ability to induce cumulative training effect. Trying to gain everything with advanced athletes will result in overtraining. For them, the **conjugate sequence system** will work pretty well.

Transition Period	GPP I		SPP I		Competition Period I				GPP II	SPP II		Competition Period II			
AA work (RE)	Hypertrophy work (SE)	MxS work (ME)		Power work (DE)	Maintenance Phase				MxS work (ME)		Power work (DE)	Maintenance Phase			
Hypertrophy work (SE)	MxS work (ME)	Power work (DE)	MxS work (ME)					Power work (DE)	MxS work (ME)						
MxS work (ME)	Power work (DE)	Hypertrophy work (SE)	Hypertrophy work (SE)					Hypertrophy work (SE)	Hypertrophy work (SE)						
Power work (DE)	AA work (RE)	AA work (RE)	AA work (RE)					AA work (RE)	AA work (RE)						

- In this scheme (CSS), couple of weeks of unload for an advanced athlete before a competition period is a must, to allow for recovery and supercompensation.
- Anyway, one should ask himself is this really needed for team athlete? How will this planning of strength training affect other training components? **When is the point of having 'enough' strength?** This point can be defined by the situation where additional gain in strength have very small influence on performance, and the workload that should be done to increase strength negatively affect other training components and create too much fatigue. For this very reason, **Rip** and **Lon** have mentioned that a lot of team athletes never need this kind of programming for strength training.
- Another point that is worth looking is that some team athletes and non-strength athletes just hit the gym with what is left from team practices and still made huge progress without any 'fancy' periodization. So, pick your methods....

- **Accumulation/Intensification Scheme**
- This scheme is a pretty simple: periods with higher volume are changed with periods of higher intensity with a 'abrupt switch' between them. Accumulation block can be used to build muscle mass or to accumulate volume and intensification block is used to unload and use delayed training effect to build strength. Pretty simple, right?

Scheme #1

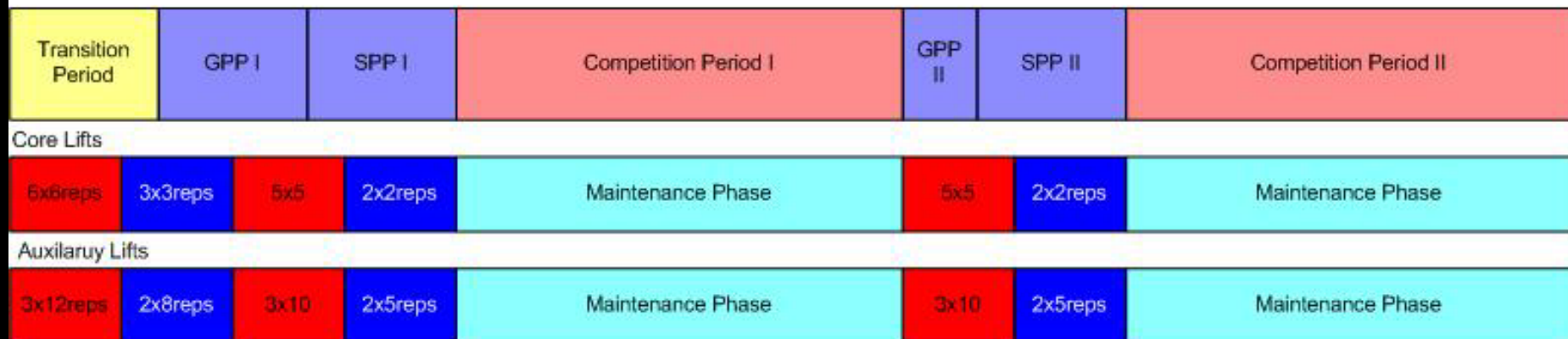

Scheme #2

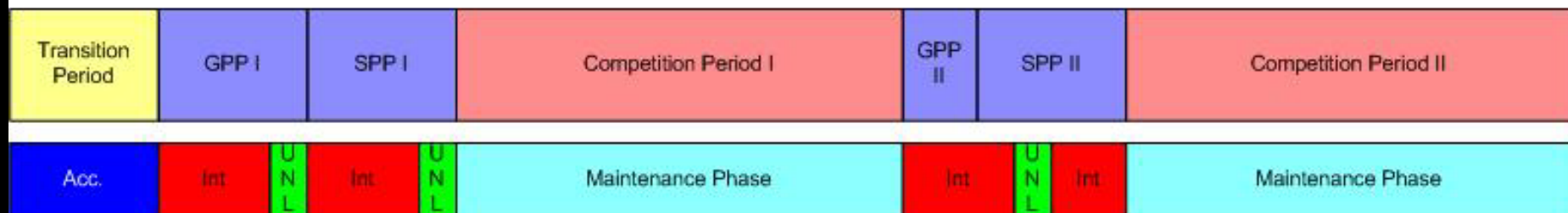

- My (current) opinion is that this form of 'periodization' can be used for all levels of the athlete. For a 'skinny novice' accumulation blocks can be used to gain some muscle mass, while intensification block can be ordinary strength block. Same goes for intermediate athlete. With advance athletes, accumulation block can be used to accumulate fatigue and in intensification block they use delayed effects.
- This method can be implemented in conjugate periodization too. Anyway, one may ask where is the line that separates the mentioned periodization methods? In theory you may identify various periodization methods, but in practice, where you have a lot of exercises, movement patterns, core and auxiliary lifts it becomes blurred. If you don't have a clear goal, this blur can disorient you easily. Planning and programming should start from clearly defined goals. The reaching for the goals must be planned around the level of the athlete and the criteria that affect your training system (like competition calendar, equipment, motivation of the athlete etc). Then you pick up the 'periodization method' and not vice versa.
- There are numerous methods of periodizations, progressions, variances and their review is not possible in this presentation, but as long as you achieve the goals, who cares whose method did you pick!?
- Now let's deal with some common goals in strength training...

- **How to increase (functional) hypertrophy of the players?**
- The first thing is the appropriate nutrition, and then comes total volume, TUT, density, etc, etc
- Athletic hypertrophy is different than bodybuilders hypertrophy, because they don't care where does it come from! For athletes hypertrophy must be myofibrillar hypertrophy mostly of fast twitch muscle fibers, and that new muscle mass should bring more power and force, so that relative strength INCREASE!
- For this reason, bodybuilding methods are not appropriate for athletes – isolation work, forced reps, muscle split, supersets, work to failure...
- There are some 'rules' for functional hypertrophy for the athletes
 1. The set (TUT) should last for about 30-40sec
 2. Lowering phase of the lift must be controlled and 'longer' than usual (3-4sec, up to 6secs)
 3. Lifting phase must be explosive and done with maximum effort – this way the fast twitch fibers are recruited and they hypertrophy much easier than slow twitch fibers
 4. Training volume must be larger than with max strength emphasis. Also training density (load/time) should be increased too.
 5. The hypertrophy phase should not last longer than 6-8 weeks with special concern of not losing strength and power and reducing relative strength and gaining a lot of fat in the process

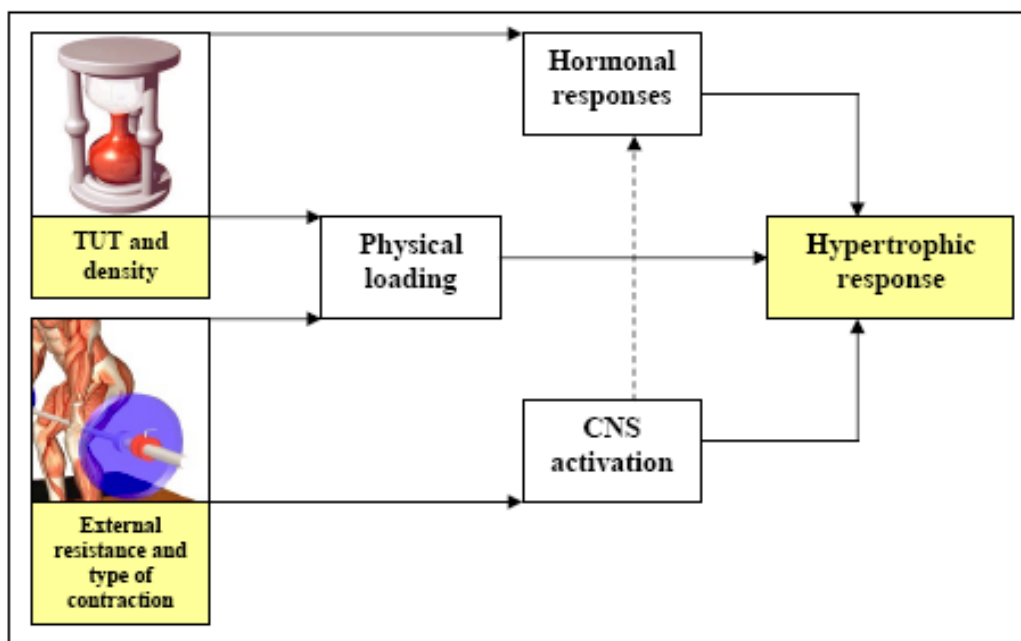

Factor	Explanation	Impact	Comments
External resistance	Represents the "mass" element of the force production equation. Generally speaking, the greater is the external load, the more force one must produce.	Heavier loading increases CNS activation and can lead to an increase in testosterone production. It can also improve the efficacy of the CNS to recruit muscle fibers. The more fibers you can recruit, the more growth you can stimulate.	Studies have show a greater increase in "test" when heavy loads were used. For example Raastad et al. (2000) found that a protocol of sets of 3RM led to a greater increase than a protocol using 70% for more reps.
Type of contraction	The way one execute the movement: eccentric, isometric or concentric (mode of contraction). Explosive, controlled or slow (speed of contraction).	Eccentric actions have a greater impact on muscle hypertrophy by increasing physical loading of the fast twitch fibers, especially if performed slowly or under control. Explosive concentric actions increase CNS activation which could also lead to an increase in testosterone production and in muscle fiber recruitment.	The best way to execute an exercise is thus to lower (eccentric) the bar slowly and lift it (concentric) explosively.
Density	The amount of work performed per unit of time (higher reps and/or shorter rests).	A higher density of work increases lactic acid production which has been show to lead to the release of hGH.	Density is probably the most important factor involved in strength training as far as modulating hGH release goes.
TUT	Time Under Tension: for how long does a muscle have to contract?	A greater TUT can also increase lactic acid production provided that it doesn't go beyond 120-180 sec. per set.	

* Taken from Thibaudeau and Roberts (2006)

- With beginners and young athletes, body-weight circuits, plate circuits, bar complexes etc, will result in muscle mass increase
- The simplest solution is to increase the number of reps in complex movements to 6-8reps per set and 8-12 in more easier exercises
- Whole body training 3x/w can be used, but with advanced athletes Upper-Lower split 4x/w or 3x/w can be used which allow greater volume per muscle group and thus greater stimulation for growth
- For the muscle mass increase, there may be a period in which all exercises use greater number of reps, but also 'concurrent' approach may be used which is maybe even a better choice (i.e. **WestSide for Skinny Bastards by Joe deFranco**) for advanced athletes
- Some methods that can be used to increase muscle mass are the following
 1. Olympic lift combinations and wide variations of squats, pulls, and presses done in the 5-8-repetition range with reduced rest (1-2 minutes) between sets are highly efficient
 2. Drop-set and Pause-Sets (not to failure)
 3. Lifting 5RM load for 5, reducing load for 10-20% and continue doing sets of 4-6resp (30X0 tempo) for about 10-20sets with short rest in between
 4. Facilitation sets followed by hypertrophy sets...

- The problem with hypertrophy is that athletes must eat a lot of food, while they also gain some fat in the process (except beginners)
- Special concern must be regarding appropriate timing of nutrition to avoid fat increase and increase muscle mass (see Kelly Baggett and Lyle McDonald work)
- There are numerous methods for (functional) hypertrophy which are not appropriate to discuss here any further
- Also, to induce muscle mass increase, modification in other training components should also take place, especially in Work Capacity and Metabolic Conditioning work
- For this reason some training periods are more suited for hypertrophy than others!
- Here are some examples of training sessions for bringing the muscle mass...

The hypertrophy program for novices...

<u>Session A</u>	<u>Session B</u>
A1. Back Squat 4x6-8 A2. Pull-Up 4x8-12	B1. Bench Press 4x6-8 B2. RDL 4x8-12
B1. Military Press 4x6-8 B2. Bulgarian Split Squat 4x8-12	C1. Seated Row 4x8-12 C2. Lunge 4x8-12

The hypertrophy program for more advanced utilizing Upper-Lower split and concurrent approach...

<u>Monday</u>	<u>Tuesday</u>	<u>Thursday</u>	<u>Friday</u>
Lower	Upper	Lower	Upper
A. Squat 3x5	A. Bench Press 3x5	A. Dead Lift 3x5	A. Military Press 3x5
B. Lunges 3x8-12	B. DB Bench Press 3x8-12	B. Bulgarians 3x8-12	B. DB Standig Press 3x8-12
C. RDLs 3x8-12	C. Rowing 3x8-12	C. Reverse Hyper 3x8-12	C. Pull-Ups 3x8-12
D. GHR 3x8-12	D. Beach work	D. GHR 3x8-12	D. Beach work

- For **maximum strength increase** there are certain 'rules'
 1. Set should last less than 20sec (TUT)
 2. Lowering phase should be under control (2-3secs)
 3. The intent to lift the weight should be maximal although the bar may raise slowly
 4. Core lifts are done with 1-5 reps
 5. Assistance lifts are done with 4-6reps and maybe more if 'concurrent' approach is used (strength and mass development/maintenance)
 6. Rest between set is 3-5mins
 7. The loads greater than 90-95% should not be used for long period of time
 8. Various unloading patterns, weeks load organization, within week alternations can be organized according to the level of the athlete and his goals
 9. With advanced athletes there may be periods in which Olys are more emphasised than compund movements and vice versa – you can't increase all lifts at the same time with advanced athletes
 10. With begginers, strength will increase also with sets with greater number of reps, although if the large number of reps impairs technique learning then 5 reps per set should be used, especially in complex lifts

- **When there is enough strength?**
 1. When additional increase in maximal strength does not bring increase in explosive strength, speed-strength and strength-speed
 2. When additional increase in maximal strength demands for great volume of work which impair development of other training components which are more important
 3. When additional increase in maximal strength demands for additional time for training and rest for the athlete

- In this case, the level of strength should be maintained and development of other components should be emphasised

- Special strength exercises?
- **Heavy sled pulls** can be considered Special Strength Exercises.
- **'Strenght in the duel'** can be also called special strength, but it corresponds more with Technical Work Component and Speed Training component
- Example are: chicken-wrestling, wrestling, playing rugby, heavy bag work, shielding the ball...

■ Organization of the training for 30players!

- I must admit that you will NEVER EVER have a chance to program strength training as written here! Why? Because if you work in a professional soccer club, you will have around 30players with different lifting experience and usually one squat rack if you are lucky
- So, the organization of strength training is far more important than your knowledge. You will NEVER EVER had a chance to express your full potential
- So, you must organize training according to number and experience of player, goals and facilities and equipment you have. And I am 200% it won't be perfect either!
- One method I 'developed' is called **Vertical Organization** of strength training (see next page)
- You must use one 'coaching intensive lift' per session and use exercises that are familiar to players. You must also have helpers, that's for sure! Usage of 'paired' exercises is very helpful in this situations
- Players may come to training in 'staggered groups'

Training A

	9:00	9:20	9:40	10:00	10:20	10:40
1st group	WARM-UP	A1. Squat A2. Pull-ups A3. Push-ups	B1. Split squat B2. Core work B3. Lateral Split squat B4. Foot work			
	2nd group	WARM-UP	A1. Squat A2. Pull-ups A3. Push-ups	B1. Split squat B2. Core work B3. Lateral Split squat B4. Foot work		
		3rd group	WARM-UP	A1. Squat A2. Pull-ups A3. Push-ups	B1. Split squat B2. Core work B3. Lateral Split squat B4. Foot work	
Equipment / Requirements	* space for warm-up		* Squat Rack, 1 bar * One coaching intense lift (squat) * Pull-up bar(s) * Space for warm-up	* Plates or DBs for Split squats * Mats for core work * Squat Rack, 1 bar * One coaching intense lift (squat) * Pull-up bar(s) * Space for warm-up	* Plates or DBs for Split squats * Mats for core work * Squat Rack, 1 bar * One coaching intense lift (squat) * Pull-up bar(s)	* Plates or DBs for Split squats * Mats for core work

- To use **Vertical Organization**, develop staggered groups, put in exercises and vertically check whether you have appropriate amount of time, space and equipment to have 2-3 groups at the same time

Work Capacity Component

- **The goals of Work Capacity Component** are aerobic power development, fat loss, rehab/prehab, corrective work, strength endurance work, core stability work...
- Work Capacity work cause LO intensity fatigue
- Work Capacity can be classified into three gruoups based on means used

Work Capacity Component		
General Means	Specific Means*	Competition Means*
Tempo Running SlideBoard Intevals Medball circuits Bodyweight circuits Plate circuits Barbell Complexes Jump Rope Sled Pulls (easy) Medball Passes Core Work	Technical work with emphasis on conditioning (pairs, triangles, squares..) Technical Poligons (circuit course) Tempo Runnin with the ball...	Easy games (handball variations, possesion games, circuit games...) Small sided games 70-90% MHR Various games that don't cause ME or HI fatigue

* For more info see *FIFA manual; Aerobic and Anaerobic Training in Soccer* by Jens Bngsbo and *Mihel Anhel Portugal* book

- Examples of SPECIFIC MEANS (taken from FIFA manual)

1. Mixed endurance circuit course with continuous training (long-interval)

Organisation:

- 3 groups of 6-8 players (depending on the players' endurance potential).
- 3 marked out zones (A - B - C).
- Duration: 15' to 30'. Change of exercise every 5' to 8'.
- Intensity: HR 140 to 160 (maintain a regular tempo).

Procedure:

- In zone A, 2 ● players run at varying tempos (forwards, backwards, sideways), starting from all four corners of the pitch.
- In zone B, ● players work in pairs with balls on passing and movement (3 or 2 touches) occupying the space.
- In zone C, each ● player runs with the ball executing various types of dribble.

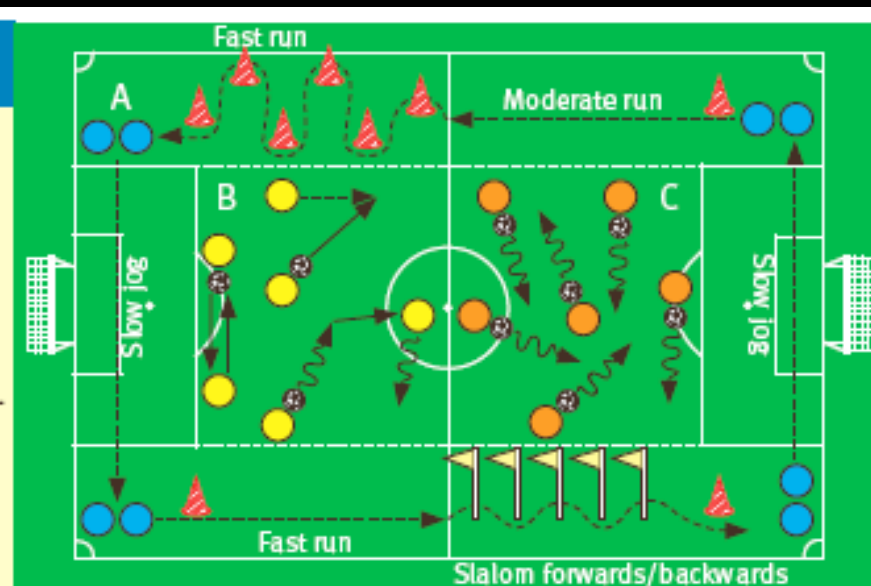

2. Endurance circuit course, running with the ball with continuous training (long-interval)

Organisation:

- 2 groups of 8 players.
- The ● players run with the ball; the ● players run at moderate pace.
- Duration: 10' to 15' with a change of position every 5' to 6'. Sets: 1 to 2.
- Intensity: HR 130 - 150 / 140 - 160.

Procedure:

- The ● players run with the ball in one direction and play the ball to the ● players, who run in the opposite direction. One-touch passes during the runs (1, 2) or pass by hand to be returned with a volley or header, etc.
- After 5' to 6', change direction.

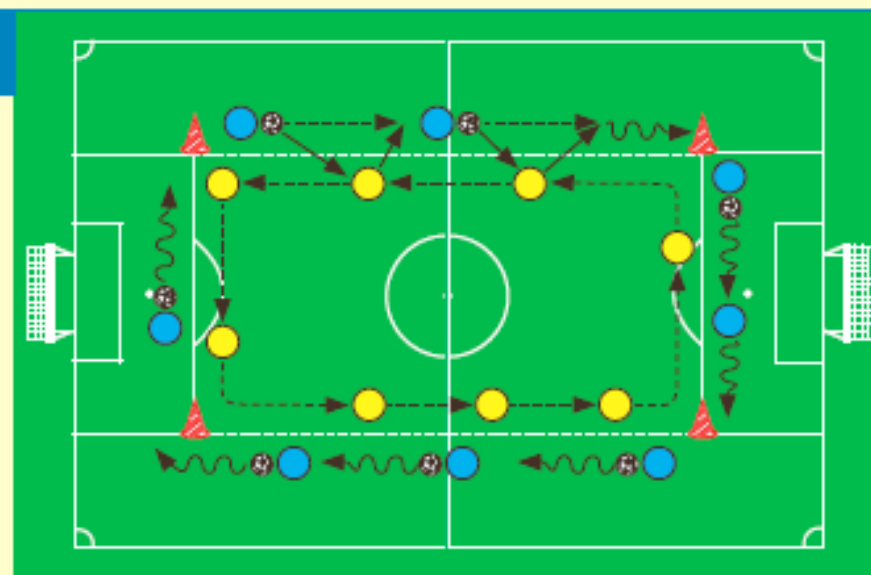

- Examples of SPECIFIC MEANS (taken from FIFA manual)

1. Technical exercise (interval training)

Organisation:

- 6 players per exercise.
- Marked out area: 2 balls in play during the exercise.
- Duration: 3' to 5'. Sets: 3 to 4x. Rest: 1' to 2'.
- Intensity: HR 160 - 170 / 180.

Procedure:

- Players **A** and **C** start at the same time.
 - **A** plays the ball short to **B**; **C** plays the ball short to **D**.
 - **B** lays the ball directly back to **A**; **D** lays the ball directly back to **C**.
 - **A** passes diagonally to **F** and follows his pass.
 - **C** passes diagonally to **E** and follows his pass.
 - **E** and **F** control and run with the ball to **B** and **D** respectively, who have taken up the positions of **A** and **C**.
- Emphasis is on maintaining the tempo of the passing (along the ground and in the air) and of the runs.



2. Intermittent training exercise (running and jumping)

Organisation:

- 2 groups of 8-9 players. - The ● players work in threes at each cone. The ● players are recovering in pairs and kicking the ball to each another. - Duration of exertion: 6' to 8'.
- Sets: 2 to 3x. Pause with technical work between sets 6 and 7.
- Intensity: HR 160 - 180.

Procedure:

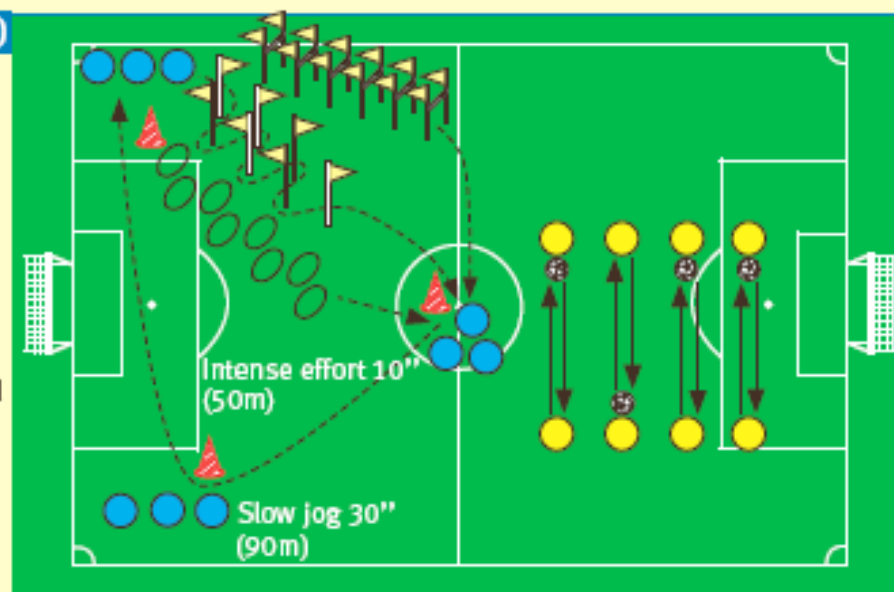

- For ● players, intensive effort of 10" (50m). • 1st stage, 6 explosive hurdle jumps with feet together. • 2nd stage, slalom and high-intensity running. • 3rd stage, 8 explosive lateral jumps (alternating between right and left leg), then intensive running.
- After this exertion, a gentle run for 30" (100m).
- For the ● players, technical exercises, with a variety of passes between the two players. - The roles are then reversed.



- Examples of SPECIFIC MEANS (taken from FIFA manual)

3. Intermittent training exercise (running and technical work)

Organisation:

– 2 groups of 8 players. – The  players are in twos and active at each technical station; the  players are in the centre of the pitch playing 6 v 2 while recovering. – Duration of effort: 5' to 6'. Sets: 2 to 3x. Rests 5' to 6'. – Intensity: HR 160 - 180.

Procedure:

– For the  players, intensive running between stations (from 5'' to 10''). – At the stations, technical exercises at a moderate rhythm of 20'' to 30'' (coaches must insist on good technical quality).

1. passes with right and left foot.
 2. individual dribbling.
 3. dribbling in twos (2 touches).
 4. dribbling and feinting.
- The  players play 6 v 2 (while recovering).

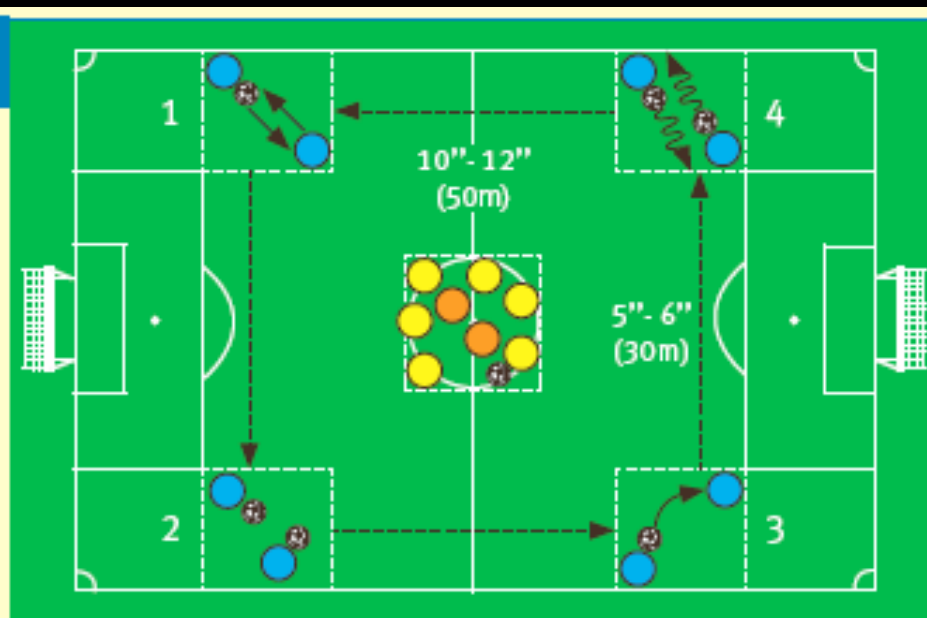

4. Combined technical-tactical exercise with intermittent training

Organisation: – The players are in their usual positions in the team formation (the positions can also be occupied by more than one player). – Normal pitch with cones in the opposition's half. – Duration: 7' to 8'. Sets 2 to 3x. Rest period: 5' to 6'. – Intensity: HR 160 – 180 / 185.

Procedure: – The players are in their usual positions in the team formation. – The ball is played between the players in the same team unit (at moderate pace). – At the coach's signal, the players do a fast run (80% of maximum speed) as far as the corresponding cones in the opposition's half and back; they then play the ball to each other again. – Intense effort 10'' to 15'' (distance 70 – 75m). Rest: technical exercise 20'' to 30''.
→ The technical skills should be varied.

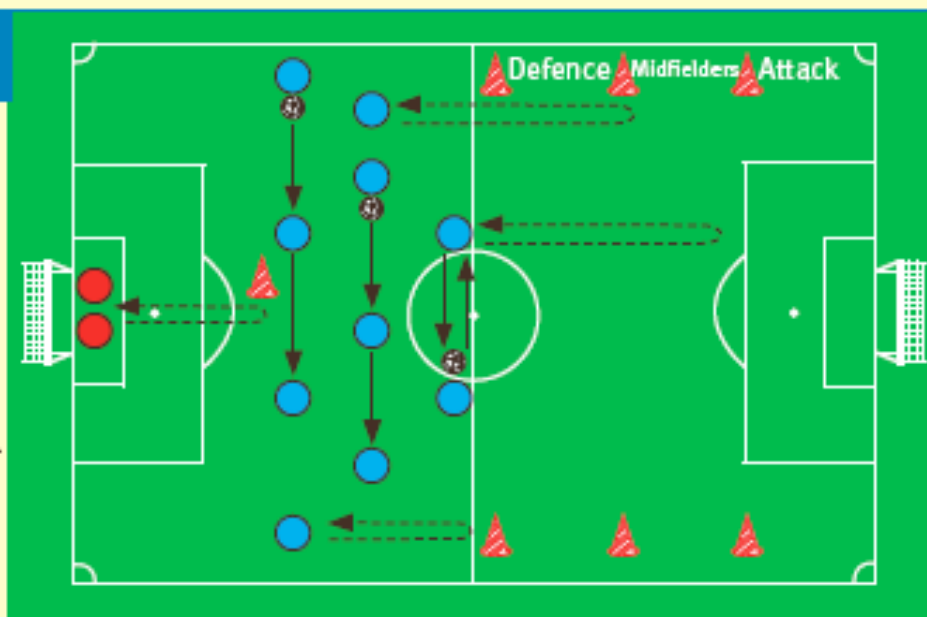

- Examples of SPECIFIC MEANS (Hoff's circuit)

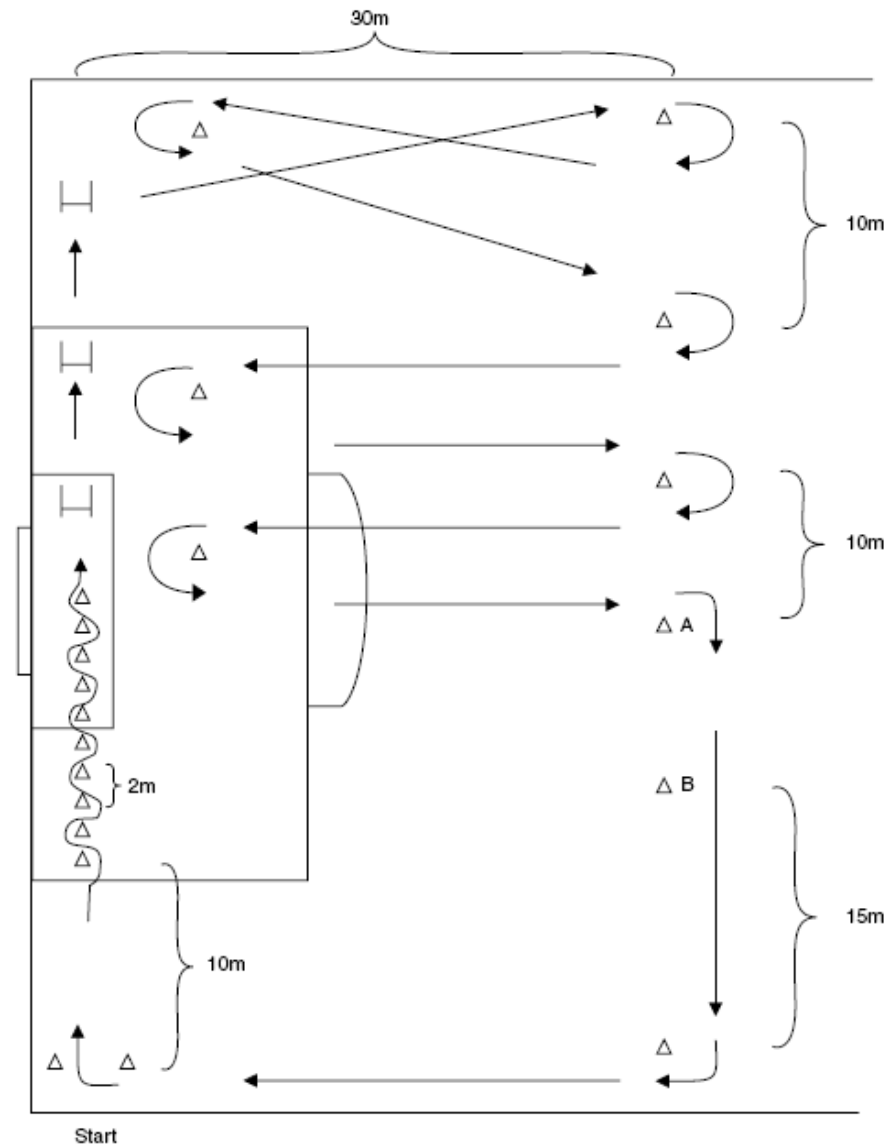

Fig. 2. Soccer-specific 'dribbling track' for training maximal oxygen uptake. The ball is dribbled in the direction of the arrows, with players running backwards between points A and B. In the experiments, players run continuously for 4 minutes (reproduced from Hoff et al.,^[65] with permission).

- Examples of COMPETITION MEANS - games (taken from FIFA manual)

3. Combined technical/tactical exercise (fartlek style)

Organisation:

- 2 teams of 10 (or 9) players at each end of the pitch.
- Players adopt the positions for the chosen playing system.
- Duration: 12' to 15'. Sets: 2x - Intensity: HR 160 - 170 /175.

Procedure:

- Each team keeps possession of the ball (gradual build-up), with limited touches (max 3).
- All the players are on the move; compact team formation, with play moved out wide.
- After 3' play, at the coach's signal, all players run two laps of the pitch starting from a cone (varied tempo), after which the exercise starts again.
- The players switch positions.
- The coach directs the exercise, dictates the tempo.

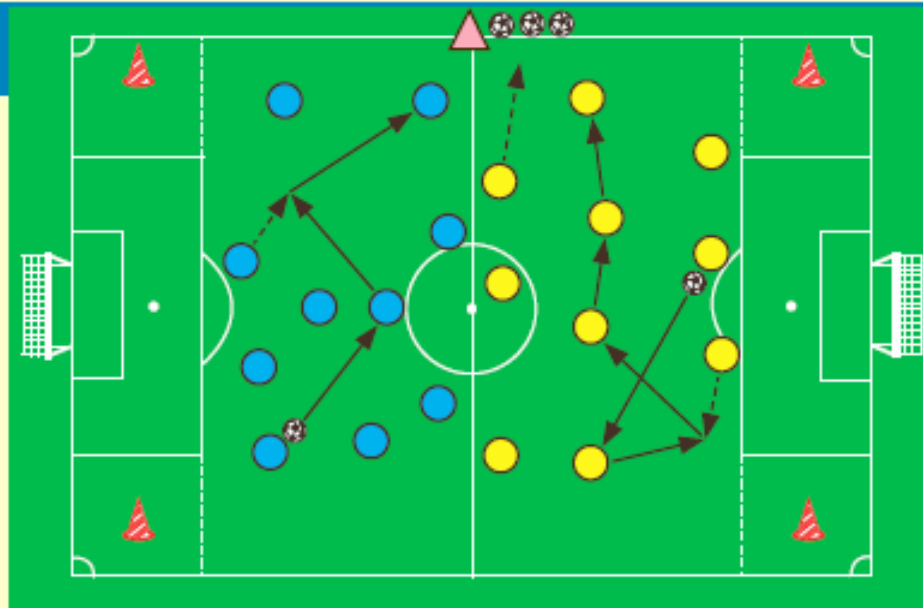

4. 6 v 6 practice game routine (fartlek style)

Organisation:

- 3 teams of 6 players + neutral goalkeeper. - Marked out playing area. - 4 small goals (2m), and one large goal in the centre of the pitch. - Duration: 15' to 30' (3x5' / 3x10').
- Intensity: HR 160-180.

Procedure:

- 2 teams playing 6 v 6. Unrestricted play or with limited touches allowed, the aim being to score in one of the opposition's small goals. - A goal is scored from a direct pass (or if a player runs through a small goal with the ball at his feet). A player can also score in the large goal, defended by the goalkeeper, by shooting directly from his own half. - During the game, the 3rd team runs around the perimeter of the playing area at varying speeds (i.e. sprint the width of the pitch, slow run along the length of the pitch). After 5' to 6', the teams are switched.

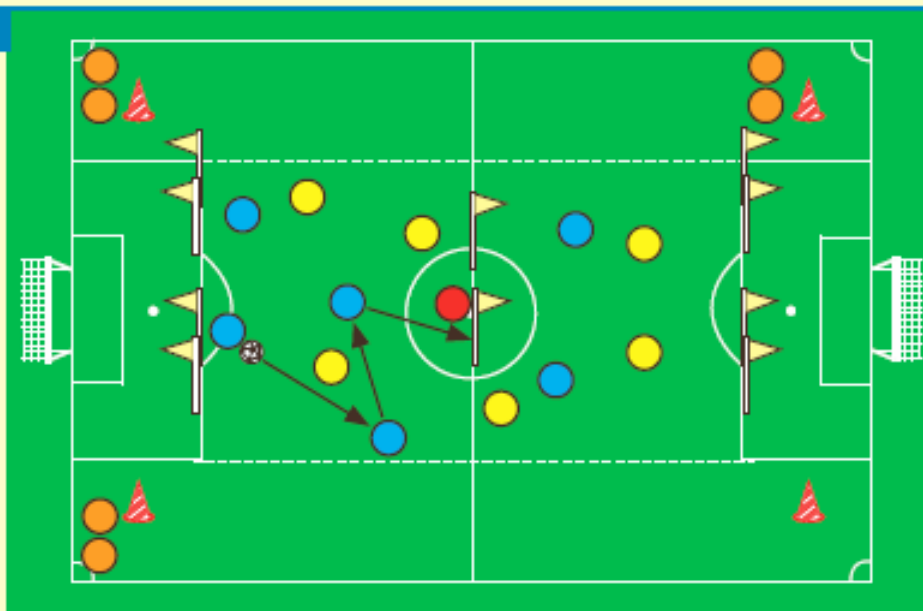

■ Examples of COMPETITION MEANS - games (taken from FIFA manual)

1. Basic endurance 8 v 8 (9 v 9) game

Organisation:

- 2 teams of 8 (or 9) players.
- Marked out playing area + 4 small goals (2 - 3m) on the flanks.
- 3 cones 15m (30m) behind the playing area.
- Duration: 10' - 15'. Repetitions: 2x. Active rest (HR returns to 120).
- Intensity: HR 150 - 175.

Procedure:

- Unrestricted play (or 3 touches): goals scored when a player crosses the goal with the ball at his feet.
- The team scoring a goal keeps possession of the ball and can go on to score in the two opposite goals in the other half.
- Halfway through the game (5' or 7.5'), the players in each team perform 3 to 5 progressive acceleration runs (70% to 100%) of 30m, with a rest of 30" between each run.

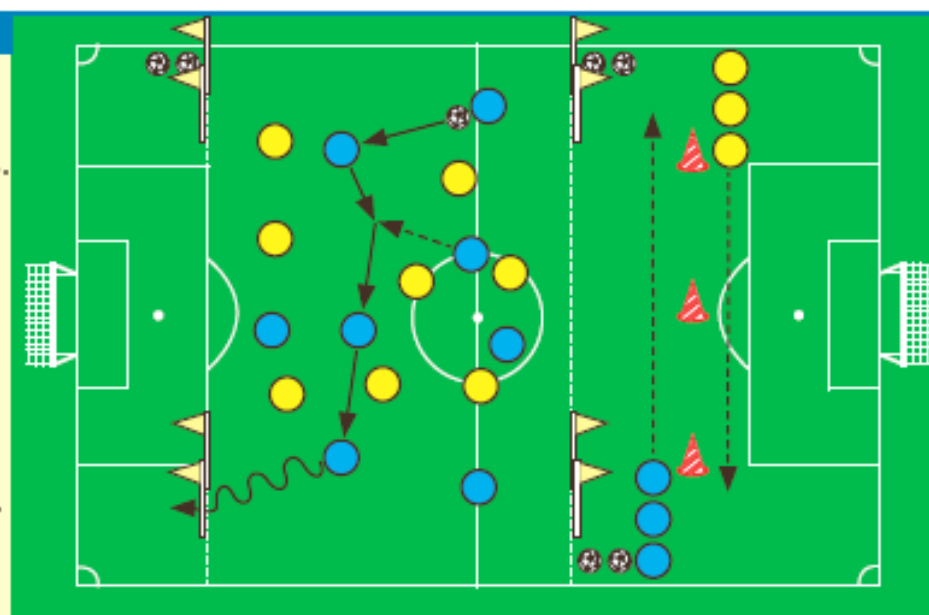

2. Retaining possession 7 v 7 game (specific endurance)

Organisation:

- 2 teams of 7 players + 2 goalkeepers who may only use their feet.
- Playing area marked out into 3 numbered zones (20 - 25m).
- Duration: 20' - 30'. Sets: 2 to 3x (6' - 10'). Active rest: 1' - 3'
- Intensity: HR 160 - 180.

Procedure:

- The players retain possession and play the ball around within the zones; unrestricted play or limited touches (3-2).
- The game can take place in a single zone, in two zones or in all three zones, depending on the instructions of the coach.
- The goalkeepers must remain in support behind the zone at all times.
- Whenever the ball goes out of play, the coach feeds in a new ball. → Count the number of passes.

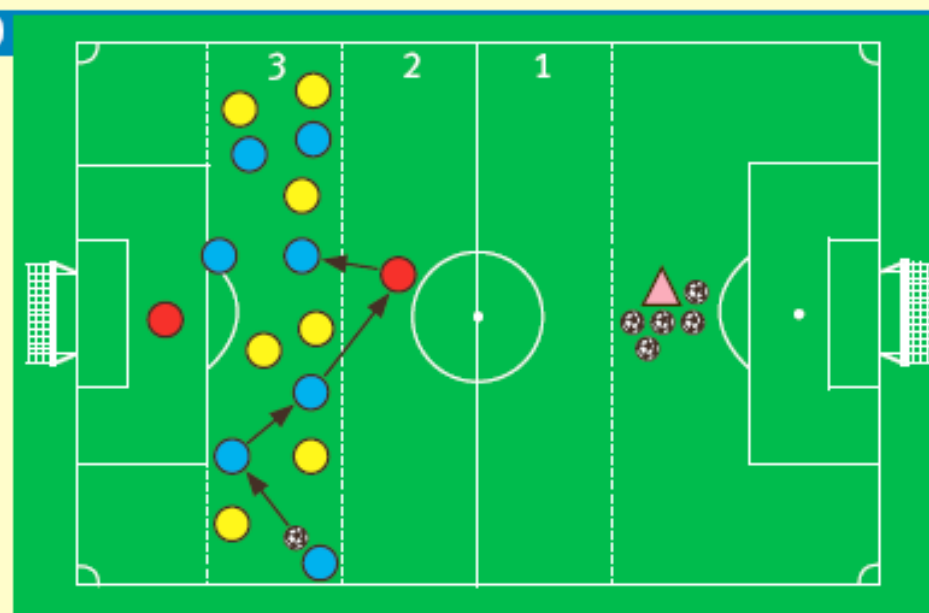

■ Examples of COMPETITION MEANS - games (taken from FIFA manual)

3. 5 v 5 game (aerobic power)

Organisation:

- 2 teams of 5 players + 2 goalkeepers (possibly with a third team recovering). - Marked out playing area + 2 large goals (enough balls must be available). - Duration: 30' to 35'.

Procedure:

- Limited-touch game in the defensive area (for the defenders).
- Unrestricted play in the attacking area (for the attackers).
- A goal is scored when all the players in the attacking team have crossed the halfway line. If any players of the other team have remained in the opponents' sector, the goal counts double.
- The goalkeepers take part in the game (playing 1 or 2 touches of the ball).
- When the ball goes out of the playing area, the coach feeds another in.

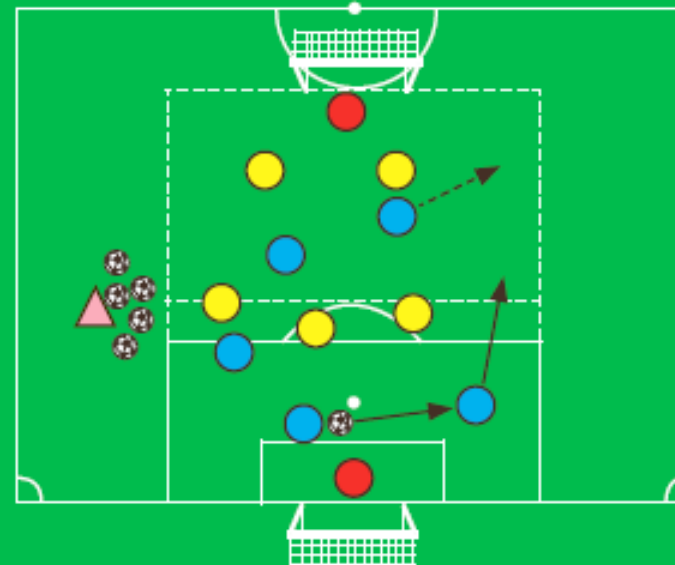

4. 4 v 4 game (maximum aerobic power)

Organisation:

- Unrestricted play 4 v 4; the goalkeeper plays the ball with 1 touch only. - 2 teams of 8 players + 2 goalkeepers. - Marked out playing area + 2 large goals (enough balls must be available). - Duration 15' to 20'. Sets 4 to 5x (3' to 4'). Rest: 3' to 4'.

Procedure:

- When the ball goes out of play, or when there is a corner, the goalkeeper of the team in possession feeds the ball back into play quickly.
- After the game has run its course (3' to 4'), the coach switches the players around.

Variations:

- 4 v 4 game with extra players who play with their team (one touch only allowed).

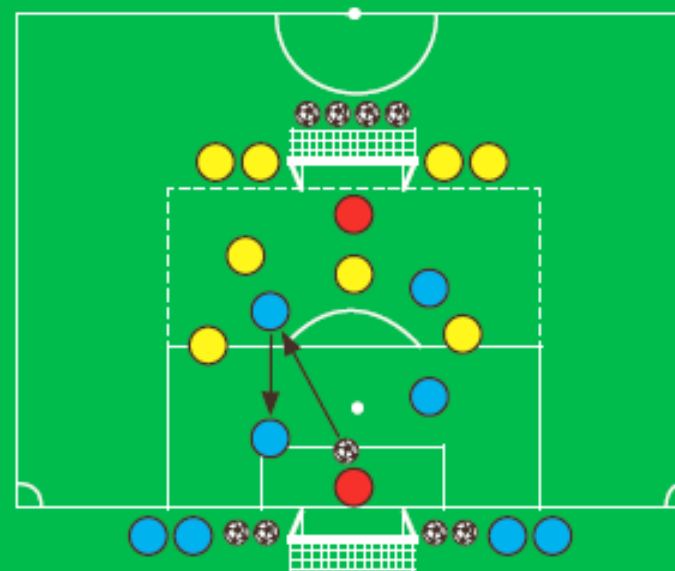

- The specific and competition means of Work Capacity Component can be considered Technical/Tactical work that corresponds to Technical and Tactical Work Components
- The design of such drills must take into account **playing style** of the team, or in other words, it should implement that kind of tactical tasks which are specific for team's style of play, and/or **position played** of the player
- Specific Means are especially useful with players who lack technical skills
- Competition Means must be done only with players who have appropriate amount of technical skill, because the technical skill will limit their conditioning.
- **Competition Means as sole means for conditioning should be used only with 'mature' and 'responsible' players, who understand that their purpose is to condition them. Other players will 'avoid effort', hide and let the ball play for them. For such players, coached directed intervals like tempo running is a better option**
- **Since mentioned Technical and Tactical means (circuit, games) represent low-level aerobic work, general Work Capacity means should be then geared more toward higher-intensity work and intervals like tempo, or in other words: NO long slow continuous runs!**

- In the mentioned examples 4on4 and Hoff's Circuit can be considered Metabolic Conditioning if they cause too much ME or HI fatigue, which will happen when they are run at 90-95% HR
- Classification of Small-Sided Games can be found in various articles and books, and it is usually based on HR and RPE
- **One thing is sure – Small Sided Games can be used for Aerobic Conditioning!!!**
- Progressions of Work Capacity 'work' can be based on increasing number of reps, duration of the reps, reducing rest time, utilizing more specific means, doing games with greater average HR, etc. Again, this depends on the goals, athlete and the context
- Implementation in Blocks can be pretty simple
 1. **Work Capacity Block:** general (more), specific (more), competition (less)
 2. **Strength, Speed and Power Block:** general (less), specific (less), competition (more)
 3. **Metabolic Conditioning Block:** general (less), competition (more)

Metabolic Conditioning Component

- **The goals of Metabolic Conditioning Component** are development of RSA and SE and 'mental toughness'
- Metabolic Conditioning cause HI and ME intensity fatigue
- Metabolic Conditioning can be classified into three groups based on means used

Metabolic Conditioning Component		
General Means	Specific Means	Competition Means
<p><u>RSA</u></p> <p>Repeated sprints Repeated explosive actions (explosive medball throws)...</p> <p><u>SE</u></p> <p>Intensive tempo Shuttles Suicides Stars, Squares...</p> <p>* Any drill that demand 100% effort for prolonged time but not more than 30sec</p>	<p><u>RSA</u></p> <p>Repeated sprints with ball Repeated 'finishings'...</p> <p><u>SE</u></p> <p>Prolonged soccer actions...</p>	<p>Duel Games (1vs1, 2vs2, 3vs3, 4vs4)</p>

Examples of General Metabolic Conditioning Drills

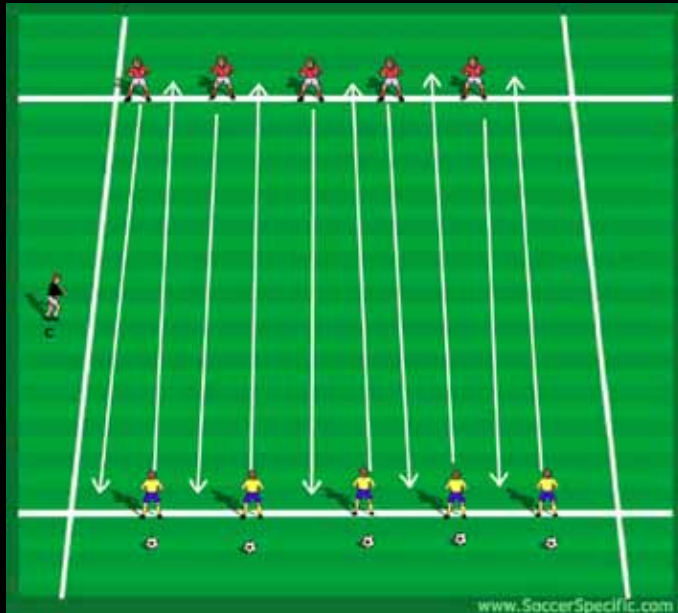

- Repeated sprints (RSA)
- Run 30-40m, rest for 30sec
- During a rest juggle, push-up, or just stand still
- Sprints can be done with a ball too

- Repeated sprints (RSA)
- Sprint from one zone to another
- During the rest, juggle, pass with a team player...
- Sprints can be done with a ball too



Examples of General Metabolic Conditioning Drills

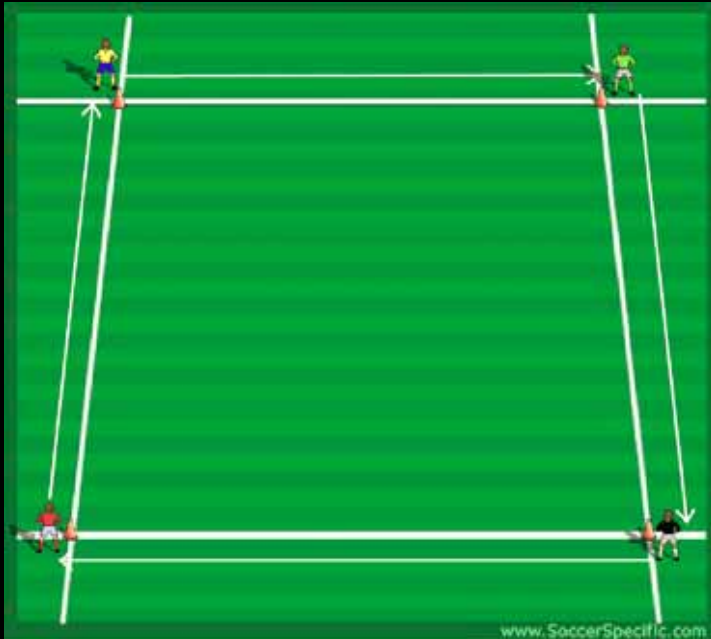

- Chase in square (SE)
- Try to catch team player within 30sec
- Body is always oriented in one direction, thus players run forward, backward, sideways

- Relays (SE)
- 120m shuttles
- Conduct 1-3 'circles'
- Last team do 20 push-ups

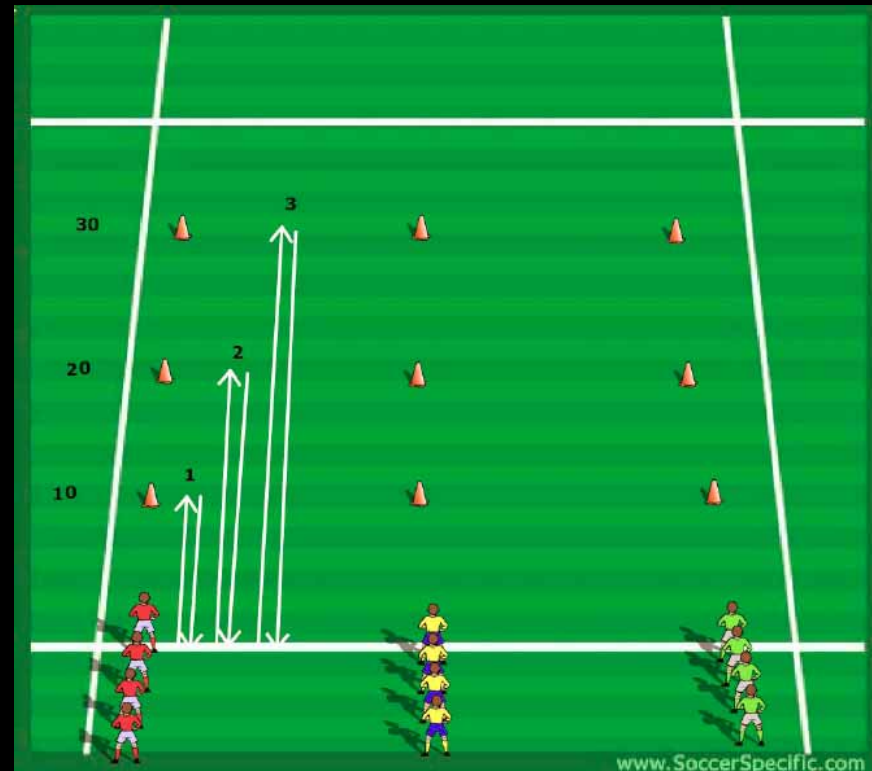

- As with speed work, with general RSA and SE training various 'games' must be used to make 'competitive environment'
- Chases and Relays should be implemented into general RSA and SE training
- Progressions can be based on increasing the number of reps, decreasing recovery time, altering number of players, etc, etc

Examples of Specific Metabolic Conditioning Drills

1. Specific interval training exercise

Organisation:

- 3 groups of players in marked out squares.
- **Square A:** Attackers. **Square B:** Defenders. **Square C:** Midfielders.
- Cones spaced out according to the distances indicated.
- 3 to 4 repetitions. 1 to 2 sets. Active rest of 1' to 1'30" between repetitions. Rest between sets: 8' - 10'.
- Intensity of effort: maximum (HR of 180 or above).

Procedure:

- Within each square, the players play 4 v 2 with one touch each; at the coach's signal, the six players start intense running:
- **A:** 10m – return, then 20m, then 30m (120m).
- **B:** 20m – return, then 40m (120m).
- **C:** 60m – return (120m).
- The last two to finish play in the middle of the 4 v 2 game.

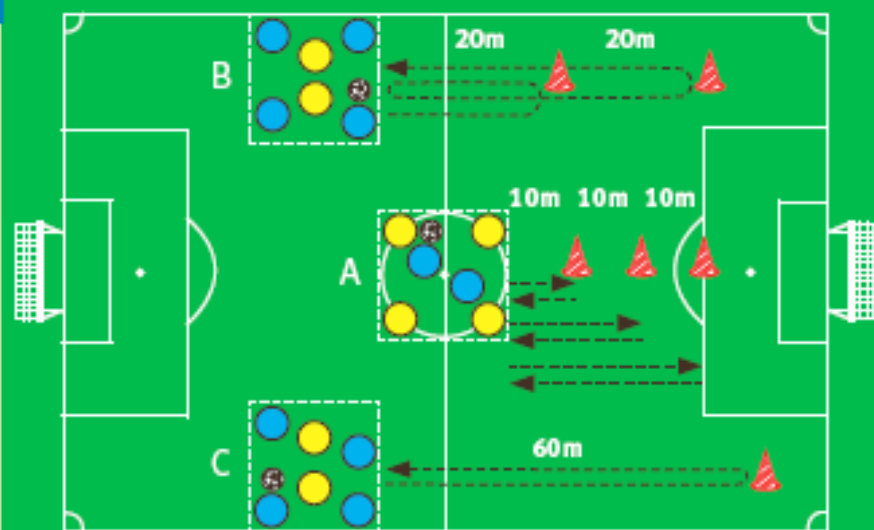

2. Exercise with finishing

Organisation:

- 6 players; 2 players on each side of the 16m line.
- Cones set out 20m from the goals for the slalom.
- Duration of effort: 30" - 45", repeated 3 - 4 times. 2 to 3 sets.
- Rest: 1'30" - 2' between repetitions. 8' - 10' between sets.
- Intensity of effort: maximum (HR of 180 or above).

Procedure:

- The first two **A** players run towards the corner of the 16m area, do a slalom run and shoot for goal after receiving the ball from player **C** 2 - 3 times in a row. – After shooting, the **A** players take the place of the **C** players; the **B** players set off. – After the last shots, the **C** players who have passed the ball retrieve the balls and move to the starting point.

Variation: Players have to vary the trajectories of the passes and shots (volleys, half-volleys). Players have to run with the ball



Examples of Specific Metabolic Conditioning Drills

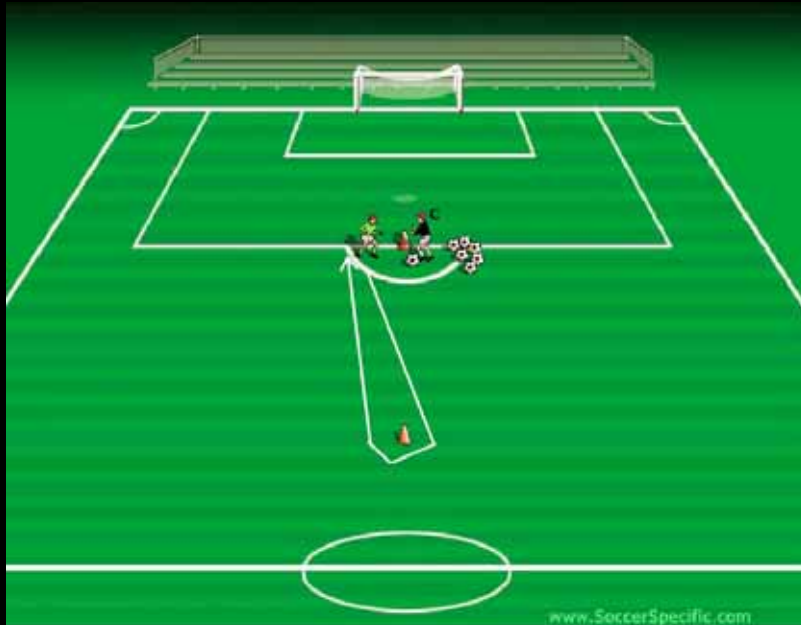

- Speed endurance with shooting
- Athletes sprint toward a cone and back, Coach serves a ball
- Athletes shoot the ball and repeat the drill for defined amount of reps or for time

- When designing Specific Metabolic Conditioning Drills, one should take into consideration team style of play and position of players
- In upper drill, attackers may shoot, while defenders may clear the ball out ...
- Progressions can be based on increasing the number of reps, decreasing recovery time

Examples of Competition Metabolic Conditioning Drills (Duels)

3. 1 v 1 exercise

Organisation:

- 6 players + goalkeepers; 3 ● defenders; 3 ● attackers.
- Duration of effort: 40" - 1' (decided on by the coach).
- Repetitions: 3 to 5. Sets 1 to 2. Rest between repetitions 2' - 2'30". 10' between sets. Intensity of effort: maximum (HR 180 or above).

→ During the exercise, another group can be in active recovery.

Procedure:

- The ● attacker A, coming from the centre, attempts to score, despite a 1 on 1 with the ● defender A. - If he loses possession of the ball or scores a goal, he goes back to the centre to take another ball. He may also play a one-two. For each new action, the defender returns to the 16m line. After the allotted time has passed, the two A players go off to the side of the playing area as extras and the B players come into the game.

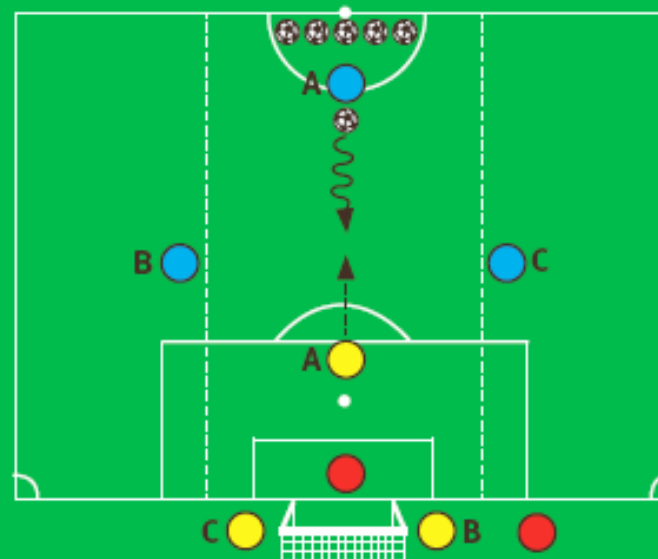

4. 2 v 2 game, with extras

Organisation:

- 2 teams of 4 + 2 goalkeepers.
- Marked out playing area (25 x 20m); 2 large goals.
- Duration of effort 1'30" - 2' (decided on by the coach).
- Repetitions: 3 to 5x. 1 to 2 sets. Rest between repetitions: 1'30" - 2'. Between sets: 8' - 10'.
- Intensity: maximum (HR 180 or above).

Procedure:

- 2 v 2 game with extra players who are allowed 1 touch of the ball. - Unrestricted play; the players attempt to score as soon as possible. - The goalkeepers are allowed a maximum 2 touches. - When the ball goes out of play, the goalkeeper of the team restarts play. - Players are switched every 1'30" - 2'.
- The coach directs play.

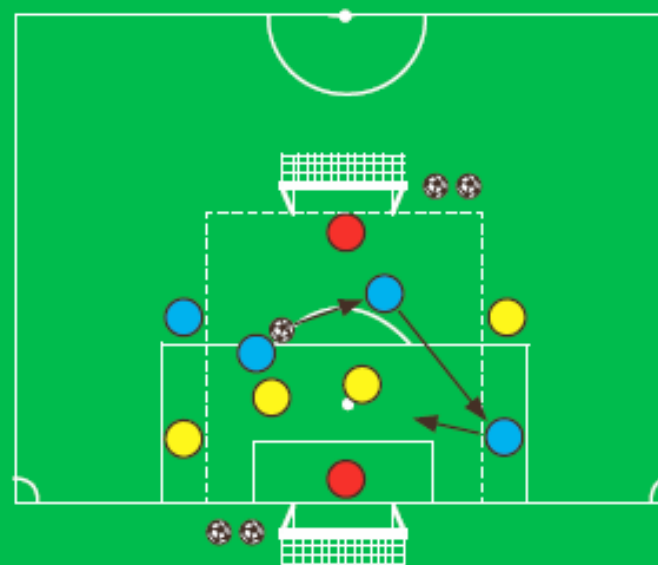

Examples of Competition Metabolic Conditioning Drills (Duels)

4. 4 v 4 game (maximum aerobic power)

Organisation:

– Unrestricted play 4 v 4; the goalkeeper plays the ball with 1 touch only. – 2 teams of 8 players + 2 goalkeepers. – Marked out playing area + 2 large goals (enough balls must be available). – Duration 15' to 20'. Sets 4 to 5x (3' to 4'). Rest: 3' to 4'. – Intensity: HR 170 - 190.

Procedure:

– When the ball goes out of play, or when there is a corner, the goalkeeper of the team in possession feeds the ball back into play quickly.
– After the game has run its course (3' to 4'), the coach switches the players around.

Variations:

– 4 v 4 game with extra players who play with their team (one touch only allowed).

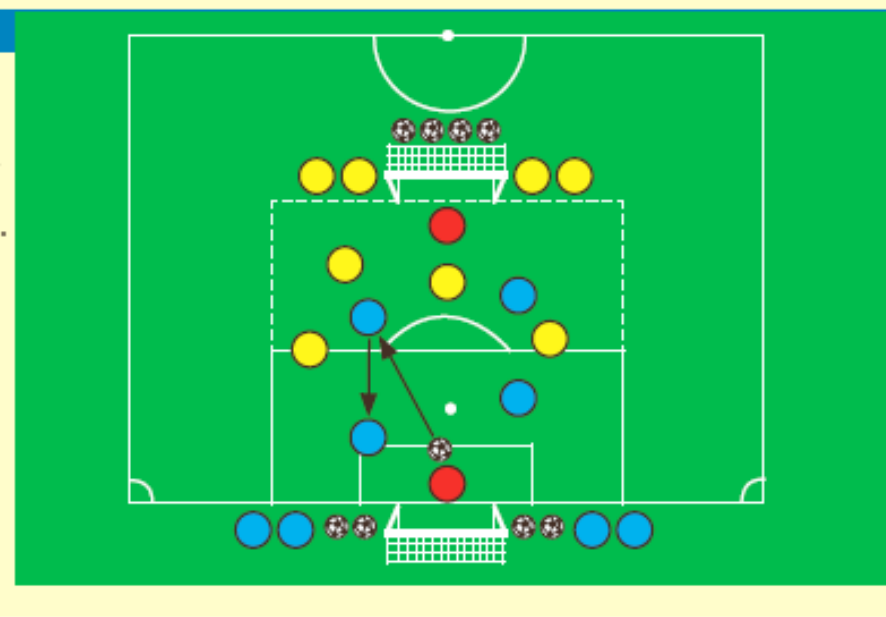

- Duels and small-sided games are always the better option than any RSA and SE training
- But, for optimal execution you will have to have skillfull, 'mature' and 'responsible' players
- There is less possibility for injury in small-sided games than with traditional conditioning
- Progression can be based on increase the number of reps, duration of the reps or decreasing the rest period between the reps

Recovery

- **Recovery means and methods** can be classified into the following groups

Recovery means and methods			
Primary Methods	Training Methods	Medicine Methods	Psychological Methods
<ul style="list-style-type: none"> • Living habits • Sleep quality • Nutrition • Social factors (school, friends, girlfriend, family..) • etc 	<ul style="list-style-type: none"> • Optimal planning and programming of training • Unloading periods • ‘Recovery’ training sessions • etc 	<ul style="list-style-type: none"> • Supplements • Pharmacological means • Physio-profilactic means (massage, sauna, baths...) • Forbidden means – dopping • etc 	<ul style="list-style-type: none"> • Progressive relaxation • Autogenic training • Visualization • Meditation • etc

- After certain period tempo and other work-capacity means may become 'recovery' means
- Even the 'running in the woods' may become a form of 'recovery', to refresh the players
- **Contrast baths** and **massage** are the most used options along with sauna
- As for nutrition, **Berardi's 7 habits of highly effective nutrition** are simple and good advice
- Talking to some experts in nutrition (Lyle McDonald) supplementation protocol may consists of
 1. **During training (starting at warm-up) * Players should experiment during training to find what suits them the most**
 - 1l/h of water (depending on the temperature)
 - 30-60g/h CHO (3-6%)
 - 8-15g/h Proteins (0,8-1,5%) (1/4 CHO)
 - The hotter the temp, the more water and less CHO and proteins
 2. **After the training (PWO shake)**
 - 500ml water
 - 0,4g/kg proteins (30g) (6%)
 - 0,8g/kg CHO (60g) (12%) (maybe even more after RSA and SE training sessions)

- Meals 2-3h before training sessions and in period of 2h after the training session must be rich in CHO to fill and re-fill glycogen stores
- Even a day of glycogen re-fillment may be used before a match
- In other meals **Berardi's** recommendations are appropriate to follow
- The issues of nutrition are very complex. Take for example the nutrition for fat loss in a little 'fatter' player, but without the drop in performance, or increasing muscle mass without gaining fat in the process... These are all real life examples and troubles that are way to complex to be addressed here. For more info I suggest you read Kelly Bagget's and Lyle McDonald work

Warm-Up

- The contents of **warm-up** depends on what is done in the session, what is the temperature, is it morning or evening session, time available, etc...
- The full training warm-up may consist of various phases: (not all exercises are done)

Full Training Warm-Up			
Joint Circles & Stretches	Activation and exercises in place	'Coordination' in motion	Specific Warm-Up
1. Foam Roll 2. Joint Circles 3. Hip flexor stretch 4. Adductor Stretch 5. Calf Stretch 6. Hip rotators stretch 7. Scorpions...	1. Scapulae and glutes activation 2. Abductors and external hip rotators activation 3. Hip flexors activation 4. Core activation 5. Push Ups 6. Split squats/Lunges/Lateral/M. Climbers 7. SL RDL 8. Wide-outs, gate swings...	1. Arm swings 2. Hip circles 3. Toy Soldiers 4. Leg swings 5. Lunges 6. Butt-kicks 7. Carioca 8. Skip 9. Shuffle 10. Cross-over 11. Shoulder tackle 12. Running mechanics 13. Accelerations	1. Technique drills 2. Tag games 3. Progressive sprints 4. Barbell Complexes 5. Medball passes 6. Possession games, shooting and sprints

- The warm-up must be dynamic, although I allow some static stretching cause players are accustomed to stretch a little. Maybe for psychological reasons, but who knows... I give them a period to stretch but not for long
- Organization of the warm-up may be changed but its dynamic nature, progressions are something that we believe prepare us for training
- Sometimes only specific warm-up is done, due time limits etc, yet again we use progressions from easy to hard and from general to specific
- Warm-up may become boring over time, but it is very important and also maintains and even improves dynamic flexibility of the players
- During warm-days the warm-up is little shorter and progress faster in intensity
- **Match warm up** may consists of: work in pairs (jogging and passing a ball while doing arm circles, hip circles etc), 'coordination', possession game interspread with little stretching or additional dynamic work, then sprints and shooting at goal, crosses etc. After this, while they wait players may work in pairs passes, heading and do whatever they feel like doing

In-season training

- With pro soccer clubs, in-season is very long and preparatory periods and transitional periods almost non-existent
- This brings into question most of the material I have covered here, like sport form, CSS and maintenance in the in-season for example
- If you don't have time to develop something, how can you then 'maintain' something?
- Also, peaking for whole competition period is impossible since it is damn long
- So, instead of being in top shape during one part of competition period, players should be at above of 90% most of the time and trying to be healthy and without injuries. Peaking and top-shape may be planned for play-offs, World Cups etc, but it is very complex process because players are already 'drained' from the league competitions
- Also, not all players should be at sport form at the same time. A 'rotation' may be implemented as well planning of sport form (peak shape) for key players
- The old approach is that in in-season players 'maintain' qualities and work on tactics and metabolic conditioning.
- Instead, players should emphasise tactics and speed and power development!
- **Hell**, they should continue working on almost all aspects and even switch emphasis like in preparatory period

- Planning in in-season is very, very complex and it is not a pre-defined pattern!
- Coach must have a 'feel' for game shape of the whole team and players, and **plan form match to match**. Having defined priorities and clear goals is also helpfull
- This 'feel' is the characteristic of the top-level coaches, and I don't know if they are born with it or they acquire it with experince... But one thing is sure: this is what separate elite coaches from great coaches.
- Planning in the in-season is also determined by competition calendar. For example, in the preceding week before a match with weaker opponent the training volume may be increased, while in the week with stronger opponent the training volume must be decreased
- Coach should also direct his training toward the 'key players' and their reacton to training and competitions loads
- Thus, loads during the in-season are not-linear and not stable!
- Coach may also utilize **mini-taper** before play offs
- But before utlizing taper, coach may 'refresh' players by changing place of training sessions and assistance exercises (those exercises and drills that have 2nd importance). The training 'rhythm' (loads, general/specific ratios, frequency) should remain the same. This way, coach trys to extent sport form as long as posible

- For **mini-taper** it is important to suddenly and progressively reduce training volumes, but maintain training intensities and 'rhythm' while keeping the same week structure and frequency.
- If the frequency is reduced, there may be a '**loss of feel**' because soccer is very skill-oriented sport
- Location of training sessions can be changed too, along with implementing some new exercises for 2nd importance drills. This should mentally refresh the players
- The goal is to maintain fitness levels and to try to reduce fatigue levels, refresh the players mentally and extend the sport form
- The mini-taper is the 'last chance method'. After it, you go to vacation, without increasing training volume again. So it is done for the play-off, last matches in the league etc.
- During the in-season, you also have bench-guys to consider. The best that can happen is to organise friendly matches with bench-guys. Depending on the coaches 'philosophy' you can 'drain' the bench guys with metabolic conditioning work or keep them fresh because they may be needed later. Ofcourse, coach must not allow de-training of the bench-guys!
- Again, in-season planning is very complex and it will not be considered here in great detail.

About the Author



Mladen Jovanović, born 17.10.1982. in Šabac, Serbia, finished elementary and Technical High-School for Computer Technician in Pula, Croatia, after which he went to Belgrade, Serbia in 2001. to finish Faculty of Sports and Physical Education for Strength and Conditioning coach degree.

At this moment, Mladen is writing his final paper on the subject of agility training and testing.

Mladen currently lives, studies and works as strength and conditioning coach in Belgrade, Serbia.

He can be reached at:

Cell Phone: +381 64 351 02 92

E-Mail: duxx82@gmail.com

